



M▲**GELLAN**▲**N**TM

MG5000 V2.40

MG5050 V2.40

▲**SP**▲
S P E C T R A[®]

SP5500 V2.40

SP6000 V2.40

SP7000 V2.40

STAY DTM

Reference & Installation

We hope this product performs to your complete satisfaction. Should you have any questions or comments, please visit www.paradox.com and send us your comments.

P▲**R**▲**D O X**[®]
S E C U R I T Y S Y S T E M S

Table of Contents

Introduction	1	Zone Input 1 Becomes a 2-wire Smoke Input	30
Features.....	1	Zone Timers	30
Specifications.....	1	Keyswitch Programming	31
System Overview	2	Keyswitch Numbering.....	31
Modules Current Consumption List	2	Keyswitch Definitions	31
Installation	3	Keyswitch Options.....	31
Location and Mounting	3	Wireless Features	32
Earth Ground	3	Wireless Transmitter Programming.....	32
AC Power.....	3	Viewing the Wireless Transmitter Signal Strength	32
Backup Battery	3	Supervision Options	32
MG5000 PCB Layout.....	4	RF Jamming Supervision	33
MG5050 PCB Layout.....	5	Wireless Serial Number Display.....	33
SP5500 PCB Layout.....	6	Remote Control Programming.....	33
SP6000 PCB Layout.....	7	Wireless Keypad Assignment.....	34
SP7000 PCB Layout.....	8	Viewing the Wireless Keypad Signal Strength	34
Metal Box Installation.....	9	Wireless Keypad Options.....	34
Auxiliary Power Terminals	11	Wireless Keypad Live Display Mode	35
Telephone Line Connection	11	Wireless Repeater Programming	35
Bell Output Connection.....	11	Viewing the Repeater's Signal Strength.....	35
Programmable Output Connections	11	Wireless Repeater Options	35
Single Zone Inputs.....	12	Wireless Options	36
Advanced Technology Zone (ATZ) Connections	13	Arming and Disarming Options	39
Fire Circuits.....	14	Switch to Stay Arming if no Entry Delay is opened	39
Programming Methods	15	When Delay Zone is bypassed Follow Zones become Entry Delay 2	39
WinLoad Software for Windows.....	15	Regular Arming switches to Force Arming	39
Programming Using a Keypad.....	15	Stay Arming switches to Stay Force Arming	39
Configuring the Keypad Zone Number	16	Sleep Arming switches to Sleep Force Arming	39
Programming Using A Paradox Memory Key*	16	Restrict Arming on Battery Failure	39
LCD Keypad Labels	18	Restrict Arming on Tamper Failure	39
Input Keys	18	Restrict Arming on Wireless Supervision Trouble	40
Label Sections	18	Arm/Disarm with VDMP3.....	40
Special Characters and Keypad Letter Assignment	18	Timed Auto-Arming	40
Access Codes	21	No Movement Auto-Arming	40
Access Code Length.....	21	Auto-Arming Options.....	41
Installer Code (Default: 0000 / 000000).....	21	One-Touch Arming.....	41
Maintenance Code (Default: Empty).....	21	One-Touch Bypass Programming	41
System Master Code (Default: 1234 / 123456).....	21	Exit Delay	41
User Code Options	21	Bell Squawk On Arm/Disarm with Keypad	41
Lock Master Code.....	22	Bell Squawk On Arm/Disarm with Remote Control	41
StayD Mode	23	No Exit Delay When Arming with Remote Control	41
Overview	23	No Exit Delay Beeps and No Bell Squawk When Stay/Sleep Arming	42
Entry/Exit Paths	23	Exit Delay Termination	42
Entry/Exit with a Keypad	23	Fast Exit	42
Entry/Exit with a Remote Control	23	Alarm Options	43
Window Mode and Re-arm Delay.....	23	Bell Cut-Off Timer.....	43
Advanced Settings.....	23	Recycle Alarm	43
Zone Programming	24	Tamper Recognition	43
Zone Definitions.....	24	RF Module Supervision	43
Zone Definition Status	28	Tamper Bypass Options.....	44
Zone Partition Assignment.....	28	Tamper Supervision on the Bus Module	44
Zone Options	28	Keypad Panic Options.....	44
EOL Zones.....	30	Panic Lockout Timer.....	44
ATZ Zone Doubling.....	30	Flex-Instant Delay	44
Tamper Input on APR-ZX8 ID A (Panel + 1).....	30	Reporting and Dialer settings	45
Tamper Input on APR-ZX8 ID B (Panel + 9).....	30	Zone Reporting Codes	45
Tamper Input on APR-ZX8 ID C (Panel + 17)	30	User Reporting Codes.....	45
ATZ Wiring Options	30	Special Arming Report Codes	45
		Special Disarming Report Codes	45
		Special Alarm Report Codes	45

System Trouble Report Codes 46
 System Trouble Restore Report Codes 46
 System Special Report Codes 46
 Clear Reporting Codes 46
 Reset Reporting Codes 47
 Monitoring Station Telephone Numbers 47
 Personal Dialing Numbers 47
 Reporting Formats 47
 Dialing Method 49
 Pulse Ratio 49
 Maximum Dialing Attempts 49
 Maximum Dialing Attempts - VDMP3 49
 Delay Between Dialing Attempts 49
 Switch to Pulse on 5th Attempt 49
 Alternate Dial Option 49
 Force Dial Option 50
 Recent Closing Delay 50
 Auto Test Report 50
 Closing Delinquency Delay 50
 Power Failure Report Delay 51
 Report System Disarming 51
 Zone Restore Report Options 51
 Telephone Line Monitoring (TLM) 51
 Pager Reporting Delay 51
 Pager Reporting Message Repetition 51
 Personal Reporting Delay 52
 Personal Reporting Message Repetition 52
 Disable Reporting 52

Programmable Outputs..... 53

PGM Activation Event 53
 PGM Deactivation Event 53
 PGM Delay 53
 PGM Options 53
 PGM Programming 54
 Viewing the PGM Signal Strength 54

System Settings..... 55

Version Number Display 55
 Push Button Power Reset 55
 Installer Lock 55
 Keypad Lockout Feature 55
 Battery Charge Current 55
 Partitioning 55
 Confidential Mode 55
 Installer Function Keys 56
 Daylight Savings Time 56
 Customized Daylight Saving Programming 56
 Audible Trouble Warning Except AC Failure 57
 Audible Trouble Warning on AC Failure 57
 Display Entry Delay on LCD keypad (MG32LCD) 57
 Display Exit Delay on LCD keypad (MG32LCD) 57

Settings for WinLoad Software 58

Panel Answer Options 58
 Panel Identifier 58
 PC Password 58
 PC Telephone Number 58
 Call WinLoad Software 58
 Answer WinLoad Software 59
 Automatic Event Buffer Transmission 59
 Call Back WinLoad 59
 Connecting to WinLoad 59

User Operation..... 60

Alarm Display 60
 Trouble Display 60

Part 1: Introduction

1.1 Features

- 32 zones (any of which can be wireless or keypad zones).
- 32 users and 32 remote controls (one per user).
- In-field upgrades: Update the panel's firmware by connecting it to a PC via a 307USB Interface and then using the Winload software (V2.80 or higher).
- Menu-driven programming for the Installer, Master, and Maintenance codes. This enables you to program the panel through a simple and easy to use interface, without the use of section numbers.
- Multiple telephone numbers for event reporting: Three for the monitoring station, five for personal dialing and one for pager reporting.
- Calendar with daylight savings time (enable section [730], option [1] and choose section [731] to put in the Country Code): You can now select 1 out of 18 different country groups each with its own preprogrammed local daylight savings time. You can also customize the daylight saving time by programming sections [732] and [733].
- New Sleep arming method: Similar to Stay arming, Sleep arming allows users to remain in a protected area, but provides a higher level of protection. For example, in a two-story house, the perimeter is protected with Stay arming. With Sleep arming, the perimeter as well as the main floor is protected (motion detectors, etc.), allowing you to roam the second floor and sleeping quarters.
- Connect up to 15 hardwire keypads on the 4-wire communication bus.
- Push button power reset: Convenient reset button saves time when a momentary powerdown is required as opposed to having to physically disconnect the control panel's power cables. Press and hold the RESET switch for five seconds. The STATUS LED will start flashing. Within 2 seconds of this flashing, press the reset switch again. The panel will reset to default and restart. Also, you can reset all programmable sections to factory default values in section [950].
- Available in 433MHz or 868MHz.
- Supports Memory Key (PMC-4 and PMC5).
- RF jamming supervision (section [700], option [5]): The control panel will report a trouble if the RF signal is being jammed.
- Supports SIA reporting format to central station.

1.2 Specifications

1.2.1 Magellan / Spectra SP Control Panels

- AC Power: 16Vac transformer (refer to Table 1 on page 3) with minimum 20VA rating (Rec. 40VA), 50 to 60Hz
- Battery: 12Vdc, 4Ah/7Ah
- Aux. Power: * 600mA typical, 700mA maximum, fuseless shutdown @ 1.1A
- Bell Output: ** 1A, fuseless shutdown @ 3A
- PGMs: 100mA low-current output (each PGM)
MG5000/SP5500/SP6000 = 2 on-board PGMs†
MG5050/SP7000 = 4 on-board PGMs

1.2.2 Magellan / Spectra SP Keypads

- Power input: Typically 9-16Vdc
- Current Consumption: MG32LED: 170mA, MG10LEDV/H: 95mA, MG32LRF: 40mA, MG32LCD: 110mA
- 1 standard keypad zone
- On-board anti-tamper switch (optional)
- Maximum Range: Maximum run of wire is 230m (750 feet)

Specifications may change without prior notice

* Cannot exceed 200mA for UL installations

** Cannot exceed 1A for UL installations

† PGM3 and PGM4 optional for the SP6000

1.3 System Overview

Module	Description	Maximum number per system
MG32LRF	32-Zone Wireless LED Keypad Module	8
MG10LEDV/H, MG32LED, MG32LCD, MG32I	10 and 32-Zone Hardwired LED and LCD Keypad Module	15 total including APR-ZX8
APR-ZX8	8-Zone Expansion Module	3
MG-RPT1	Magellan Wireless Repeater Module	2
VDMP3	Plug-In Voice Dialer	1
IP100	Internet Module	1
MG-RTX3	Wireless Expansion Module (Spectra SP only)	1

1.4 Modules Current Consumption List

Module	Current Consumption
MG10LEDV/H	Min. = 44mA / Max. = 72mA
MG32LED	Min. = 49mA / Max. = 148mA
MG32LCD	Min. = 43mA / Max. = 86mA
MG32LRF	Min. = 48mA / Max. = 130mA
MG32I	Min. = 30mA / Max. = 70mA
APR-ZX8	Min. = 29mA / Max. = 31mA
MG-RTX3	Min. = 61mA / Max. = 143mA
IP100	Min. = 90mA / Max. = 120mA
VDMP3	Min. = 28mA / Max. = 28mA

Part 2: Installation

2.1 Location and Mounting

Before mounting the cabinet, push the five white nylon mounting studs into the back of the cabinet. Pull all cables into the cabinet and prepare them for connection before mounting the circuit board into the back of the cabinet. Select a centralized installation site on the main floor that isn't easily accessible to intruders and leave at least 5cm (2in) around the panel box to permit adequate ventilation and heat dissipation. The installation site should be dry and close to an AC source, ground connection and telephone line connection. Avoid installation near or in the path of strong RF fields (i.e. neon lights, computers), on or near metal objects, circuit breaker boxes, air conditioners and heater ducts since they may cause interference and reduce sensitivity. Avoid installing the control panel in the basement.

⚠ Do not cut, bend or alter the antennas and ensure that electrical wires do not cross over the antennae as these may affect the signal reception.

2.2 Earth Ground

Connect the zone and dialer ground terminals from the control panel to the metallic enclosure and cold water pipe or grounding rod as per local electrical codes.

⚠ For maximum lightning protection, use separate earth grounds for the zone and dialer grounds as shown in the PCB Layouts for each respective panel. For UL installations, the metallic enclosure must be grounded to the cold water pipe.

2.3 AC Power

Do not use any switch-controlled outlets to power the transformer. Connect the transformer as shown in Figure 1 on page 3. Use Table 1 to determine the required transformer.

Table 1: Transformer Requirements Table

Transformer:	Amseco XP-1620 16VAC 20VA <i>(not verified by UL)</i>	UL: Universal UB1640W 16.5VAC 40VA
DC Power Supply rated at:	1.1A	1.5A
Auxiliary Supply can provide a maximum of:	typ: 600mA, max: 700mA	typ: 600mA, max: 700mA Do not exceed 200mA for UL installations
Acceptable Battery Charge Currents	350mA	350mA/700mA

2.4 Backup Battery

To provide power during a power loss, connect a 12Vdc 4Ah rechargeable acid/lead or gel cell backup battery as shown in Figure 1 below. Use a 7Ah battery to comply with UL fire requirements. Connect the backup battery after applying AC power. When installing, verify proper polarity as reversed connections will blow the battery fuse.

2.4.1 Battery Test

If the battery is disconnected or if the battery fuse is blown, a No/Low Battery failure will appear in the keypad's trouble display (see *Trouble Display* on page 60). This trouble will also appear if the battery's capacity is too low or if the voltage drops to 10.5V or lower while the control panel is running on the backup battery. At 8.5V or lower, the panel shuts down and all outputs close.

Figure 1: AC Power and Backup Battery Connections

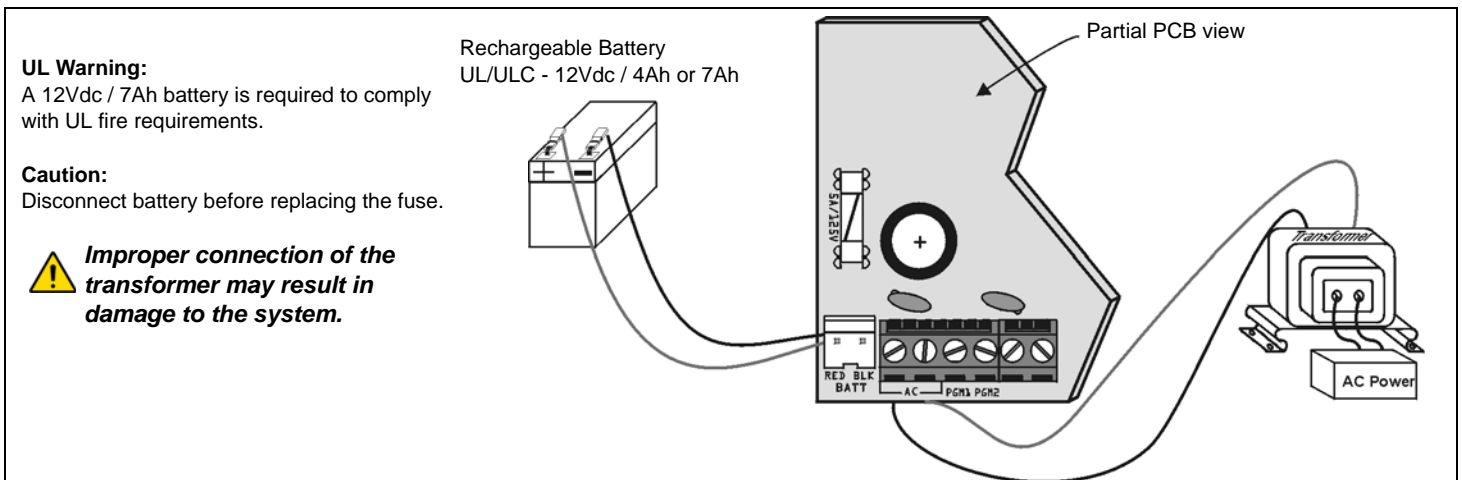

2.5 MG5000 PCB Layout

Used for In-Field Firmware upgrade through a 307USB Direct Connect Interface. See Connecting to WinLoad on page 58 for details.

EBUS and Dialer used for VDMP3 plug-in voice module for voice reporting.

Press and hold the RESET button for five seconds. The STATUS LED will start flashing. Within 2 seconds of this flashing, press the reset switch again. The panel will reset to default and restart.

Four pin connector can be used for quick installation of a MG5000 keypad.



Refer to AC Power & Backup Battery Connections on page 3.

The "BELL" output will shutdown if the current exceeds 3A.

Connection for Self-Contained Bell/Siren

Warning: The sum of the current drawn from the BELL and AUX must be limited to 1.3A (40VA transformer strongly recommended). Exceeding this limit will overload the panel power supply and lead to complete system shutdown.

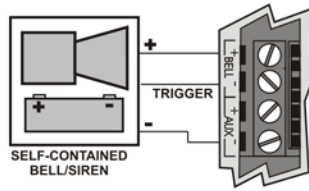

AUX Power

Refer to transformer requirements on page 3 for Aux. Power Output. To connect additional wiring to auxiliary power, use the red (+) and black (-) keypad connectors. Auxiliary power will shut down if current exceeds 1.1A. If the auxiliary output is overloaded and is shut down, you must disconnect all loads from the output for at least 10 seconds before reconnecting any load back to the auxiliary output.

Warning: This equipment must be installed and maintained by qualified service personnel only. For UL and C-UL warnings, refer to the UL and C-UL Warnings section at the back of the Reference & Installation Manual.

Charge LED:
Charging and Battery test LED

"STATUS" LED:
Flash once every second = Normal
Flashes ON 1 second and OFF 1 second = Any trouble
Always ON = Panel is using phone line
Fast flash 6 seconds after power up = Installer lock enabled

"RX" & "TX" LED:
Flashes quickly when receiving or transmitting RF signals from wireless devices.

Warning: Do not cut, bend or alter the antennas and ensure that electrical wires do not cross over the antennae, as this may affect signal reception.

Warning: Disconnect telephone line before servicing.

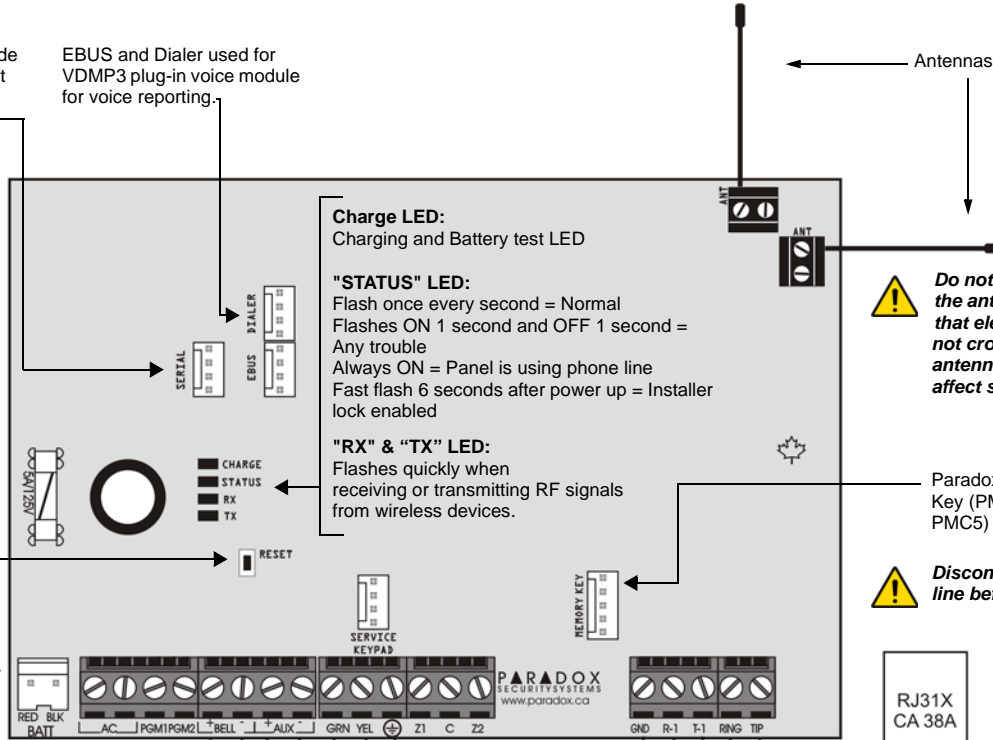

Refer to Single Zone Inputs on page 12

Warning: To provide maximum lightning protection we strongly recommend having separate earth connections for the dialer and zone ground terminals.

Warning: Max. amount of keypads = 15 keypads
Max. current = 700 mA
Max. distance of keypad from panel = 76m (250 feet)
Max. total run of wire = 230m (750 feet)

For the keypad's zone configurations, refer to the **Installer Quick Menu**. If EOL is enabled: see section [706] option [2]. Also refer to Single Zone Inputs on page 12.

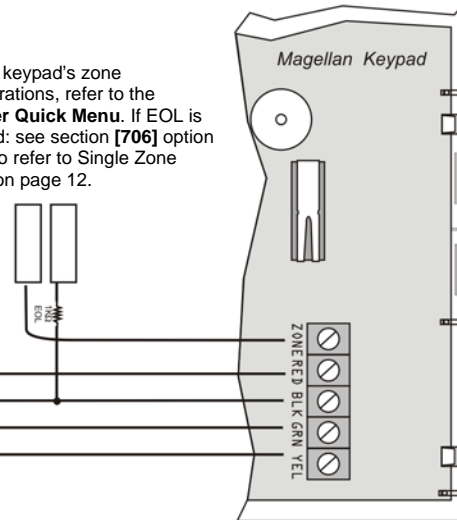

2.6 MG5050 PCB Layout

Charge LED:

Charging and battery test LED

Status LED:

- Flash once every second = Normal
- Flashes ON 1 second and OFF 1 second = Any trouble
- Always ON = Panel is using phone line
- Fast flash 6 seconds after power up = Installer lock enabled

"RX" & "TX" LED:

Flashes quickly when receiving or transmitting RF signals from wireless devices.

SERVICE KEYPAD



Four pin connector can be used for quick installation of a MG5050 keypad.

Refer to AC Power & Backup Battery Connections on page 3.

The "BELL" output will shutdown if the current exceeds 3A.

Connection for Self-Contained Bell/Siren

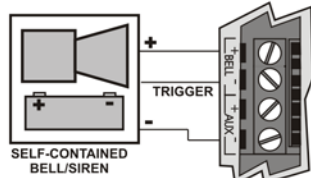

Warning: The sum of the current drawn from the BELL and AUX must be limited to 1.3A (40VA transformer strongly recommended). Exceeding this limit will overload the panel power supply and lead to complete system shutdown.

AUX Power
Refer to transformer requirements on page 3 for Aux. Power Output. To connect additional wiring to auxiliary power, use the red (+) and black (-) keypad connectors. Auxiliary power will shut down if current exceeds 1.1A. If the auxiliary output is overloaded and is shut down, you must disconnect all loads from the output for at least 10 seconds before reconnecting any load back to the auxiliary output.

Warning: This equipment must be installed and maintained by qualified service personnel only. For UL and C-UL warnings, refer to the UL and C-UL Warnings section at the back of the Reference & Installation Manual.



Do not cut, bend or alter the antennas and ensure that electrical wires do not cross over the antennae, as this may affect signal reception.

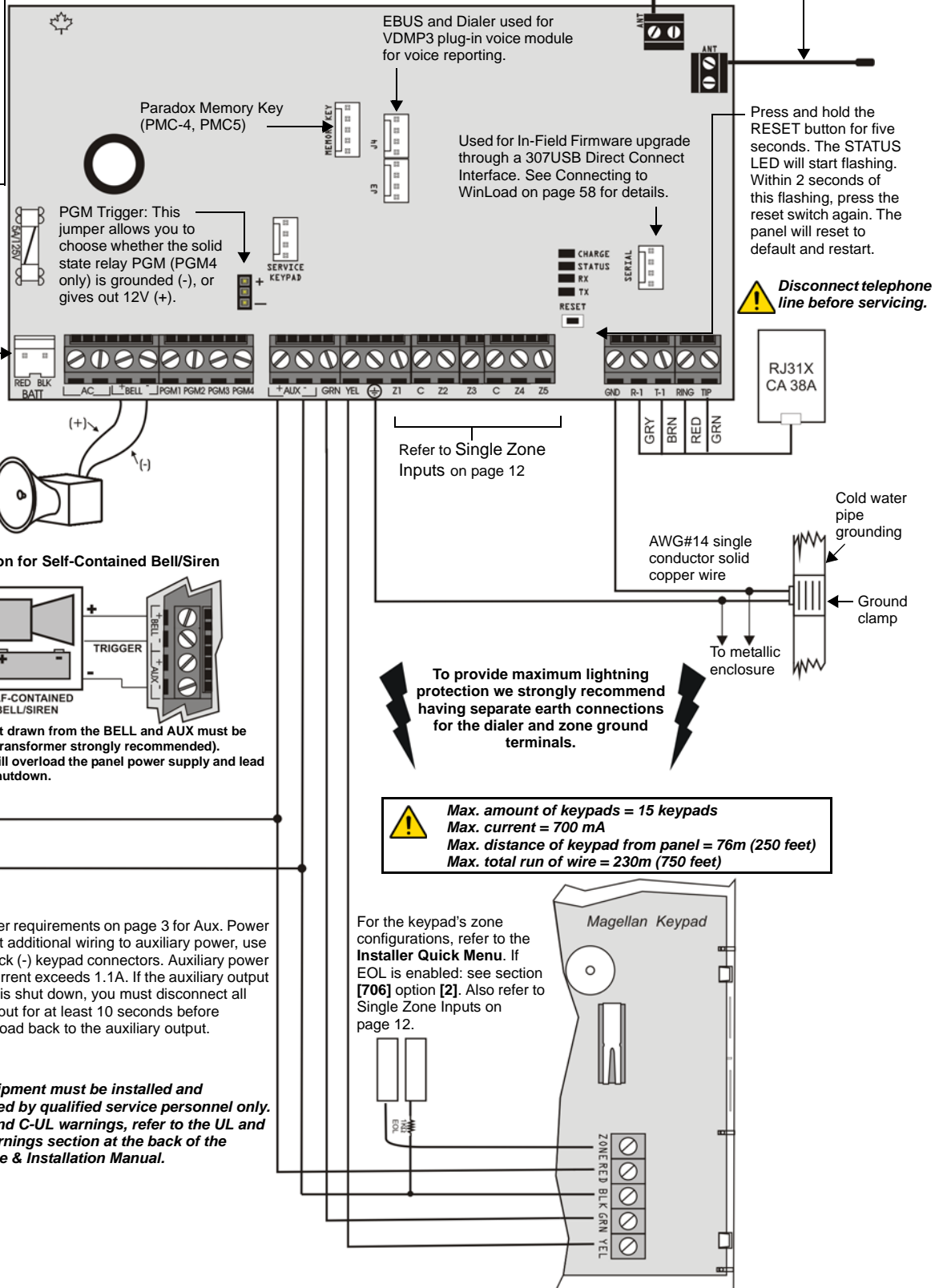

Warning: Disconnect telephone line before servicing.

To provide maximum lightning protection we strongly recommend having separate earth connections for the dialer and zone ground terminals.

Warning: Max. amount of keypads = 15 keypads
Max. current = 700 mA
Max. distance of keypad from panel = 76m (250 feet)
Max. total run of wire = 230m (750 feet)

For the keypad's zone configurations, refer to the Installer Quick Menu. If EOL is enabled: see section [706] option [2]. Also refer to Single Zone Inputs on page 12.

2.7 SP5500 PCB Layout

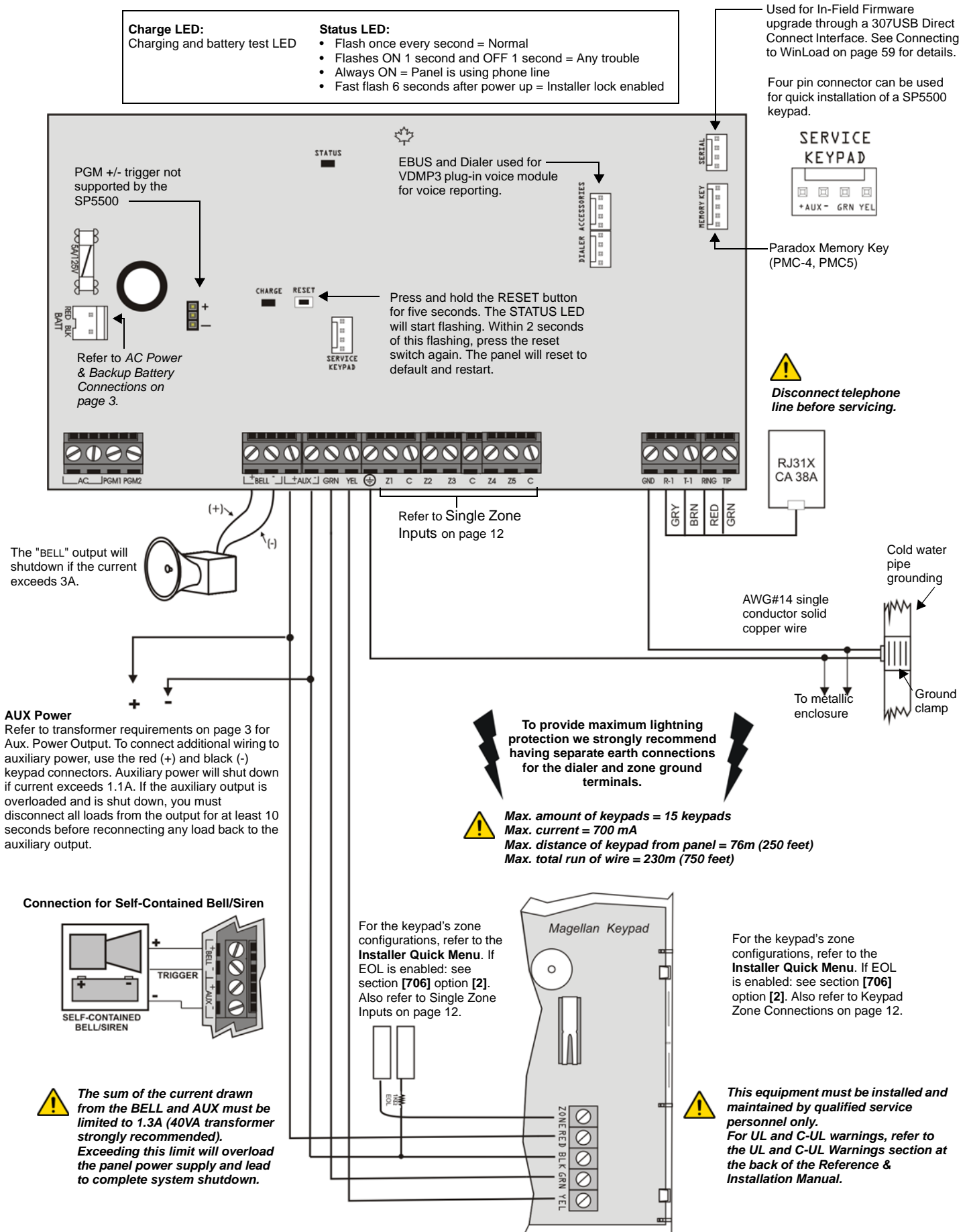

2.8 SP6000 PCB Layout

Charge LED:
Charging and battery test LED

Status LED:

- Flash once every second = Normal
- Flashes ON 1 second and OFF 1 second = Any trouble
- Always ON = Panel is using phone line
- Fast flash 6 seconds after power up = Installer lock enabled

Used for In-Field Firmware upgrade through a 307USB Direct Connect Interface. See Connecting to WinLoad on page 59 for details.

Four pin connector can be used for quick installation of a SP6000 keypad.

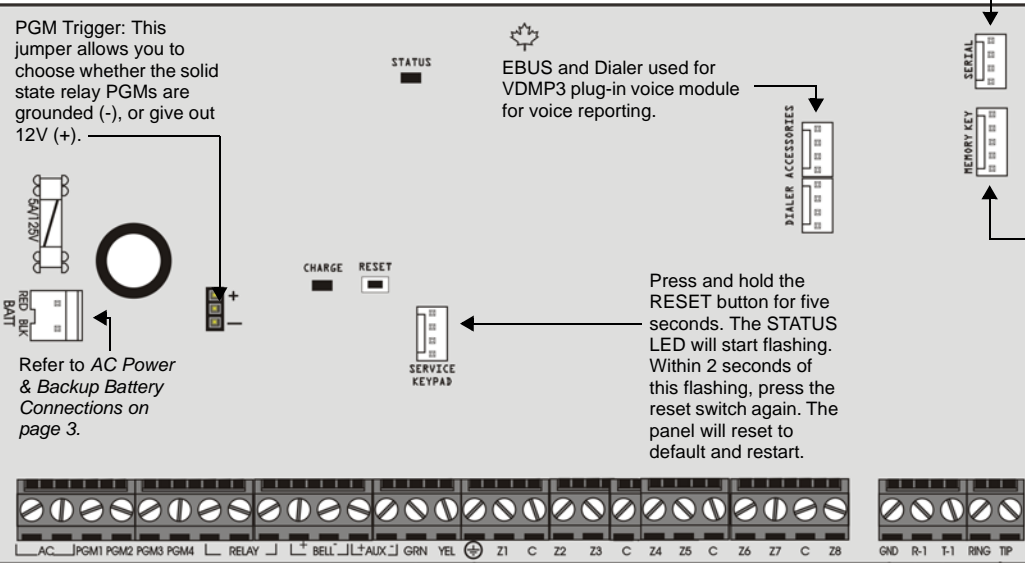

Paradox Memory Key (PMC-4, PMC5)

Disconnect telephone line before servicing.



PGM3, PGM4, and the alarm relay are optional.

The "BELL" output will shutdown if the current exceeds 3A.

AUX Power
Refer to transformer requirements on page 3 for Aux. Power Output. To connect additional wiring to auxiliary power, use the red (+) and black (-) keypad connectors. Auxiliary power will shut down if current exceeds 1.1A. If the auxiliary output is overloaded and is shut down, you must disconnect all loads from the output for at least 10 seconds before reconnecting any load back to the auxiliary output.

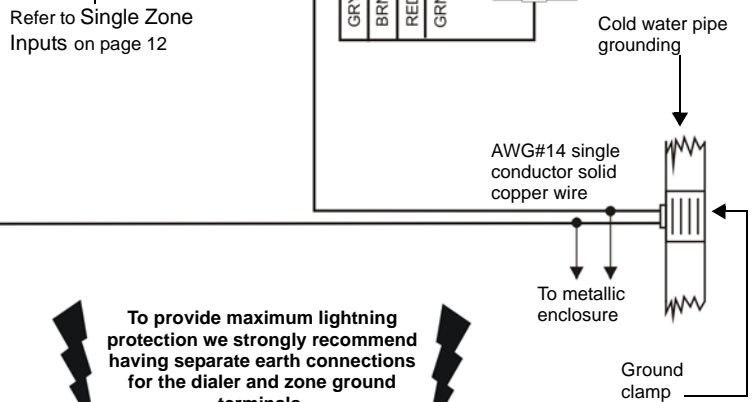

Max. amount of keypads = 15 keypads
Max. current = 700 mA
Max. distance of keypad from panel = 76m (250 feet)
Max. total run of wire = 230m (750 feet)

Connection for Self-Contained Bell/Siren

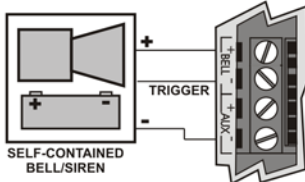

The sum of the current drawn from the BELL and AUX must be limited to 1.3A (40VA transformer strongly recommended). Exceeding this limit will overload the panel power supply and lead to complete system shutdown.

For the keypad's zone configurations, refer to the **Installer Quick Menu**. If EOL is enabled: see section [706] option [2]. Also refer to Keypad Zone Connections on page 12.

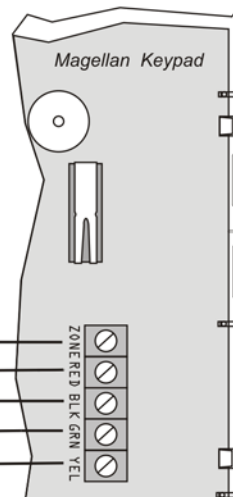

When using an SP6000 panel in conjunction with an MG-RTX3, all MG32LED and MG10LEDV/H keypads must be versions 2.0 or higher.

This equipment must be installed and maintained by qualified service personnel only. For UL and C-UL warnings, refer to the UL and C-UL Warnings section at the back of the Reference & Installation

2.9 SP7000 PCB Layout

Charge LED:

Charging and battery test LED

Status LED:

- Flash once every second = Normal
- Flashes ON 1 second and OFF 1 second = Any trouble
- Always ON = Panel is using phone line
- Fast flash 6 seconds after power up = Installer lock enabled

Press and hold the RESET button for five seconds. The STATUS LED will start flashing. Within 2 seconds of this flashing, press the reset switch again. The panel will reset to default and restart.

RESET

STATUS
CHARGE

DIALER ACCESSORIES

EBUS and Dialer used for VDMP3 plug-in voice module for voice reporting.

SERIAL
MEMORY KEY

SERVICE
KEYPAD

Four pin connector can be used for quick installation of a SP7000 keypad.

Paradox Memory Key (PMC-4, PMC5)



PGM Trigger: This jumper allows you to choose whether the solid state relay PGMs are grounded (-), or give out 12V (+).

Refer to AC Power & Backup Battery Connections on page 3.

SERVICE
KEYPAD

Upper Inputs = Zones 9 to 16
Lower Inputs = Zones 1 to 8



Disconnect telephone line before servicing.

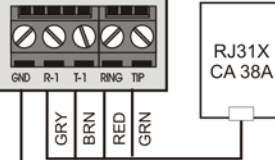
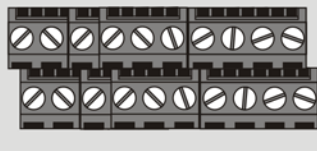

Refer to Single Zone Inputs on page 12

The "BELL" output will shutdown if the current exceeds 3A.

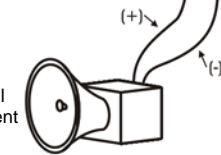

AUX Power

Refer to transformer requirements on page 3 for Aux. Power Output. To connect additional wiring to auxiliary power, use the red (+) and black (-) keypad connectors. Auxiliary power will shut down if current exceeds 1.1A. If the auxiliary output is overloaded and is shut down, you must disconnect all loads from the output for at least 10 seconds before reconnecting any load back to the auxiliary output.

Connection for Self-Contained Bell/Siren

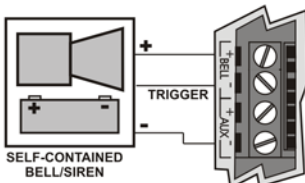

The sum of the current drawn from the BELL and AUX must be limited to 1.3A (40VA transformer strongly recommended). Exceeding this limit will overload the panel power supply and lead to complete system shutdown.

For the keypad's zone configurations, refer to the **Installer Quick Menu**. If EOL is enabled: see section [706] option [2]. Also refer to Keypad Zone Connections on page 12.



To provide maximum lightning protection we strongly recommend having separate earth connections for the dialer and zone ground terminals.



Max. amount of keypads = 15 keypads
Max. current = 700 mA
Max. distance of keypad from panel = 76m (250 feet)
Max. total run of wire = 230m (750 feet)

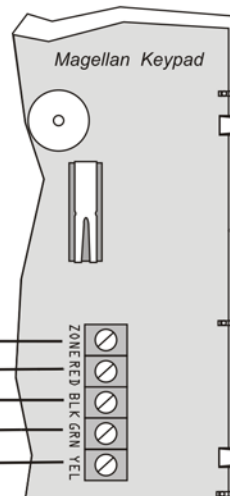

For the keypad's zone configurations, refer to the **Installer Quick Menu**. If EOL is enabled: see section [706] option [2]. Also refer to Keypad Zone Connections on page 12.



This equipment must be installed and maintained by qualified service personnel only. For UL and C-UL warnings, refer to the UL and C-UL Warnings section at the back of the Reference & Installation Manual.

2.10 Metal Box Installation

The crosses and dotted line represent the mounting location. If you need specific dimensions, contact Paradox Distributor Support. For UL recommended installation for the MG5000 only, place the PCB one notch lower than the mounting location.

MG5000 (8x10")

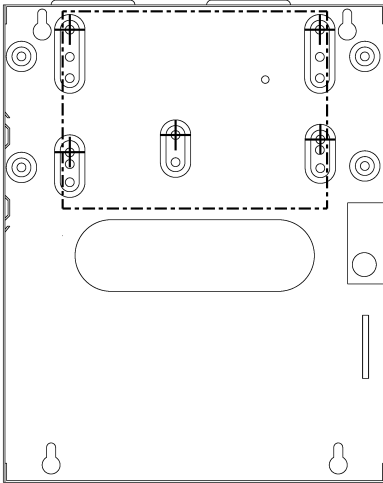

MG5000 (11x11")

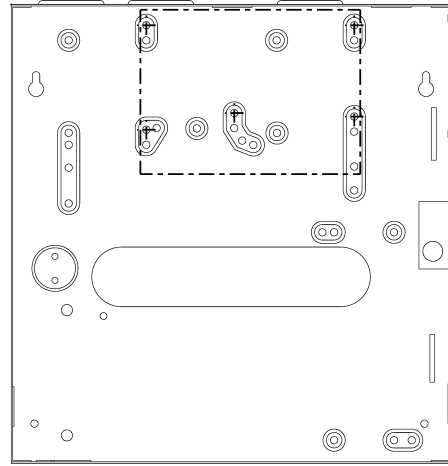

MG5050 (11x11")

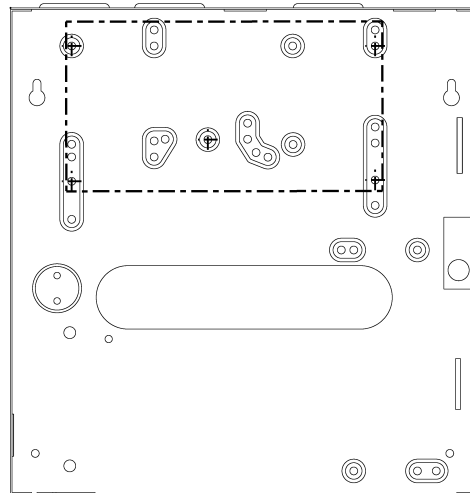

SP5500 (8x10")

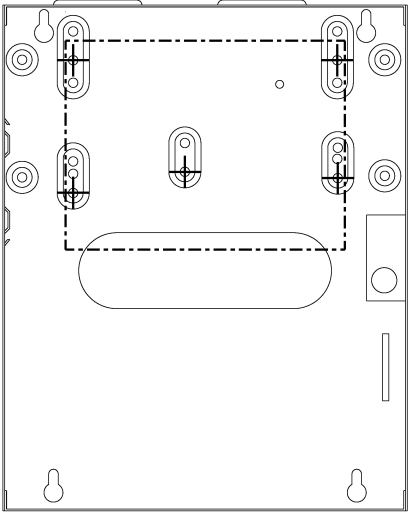

SP6000 (11x11")

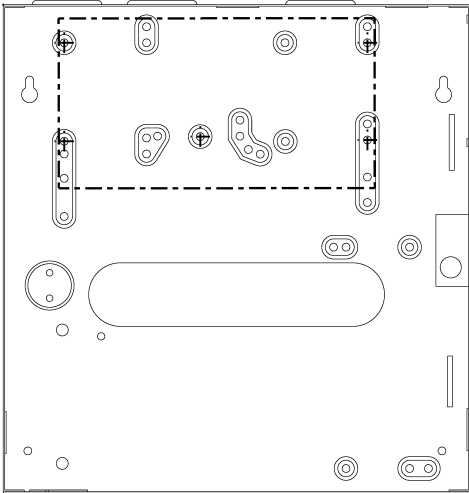

SP7000 (11x11")

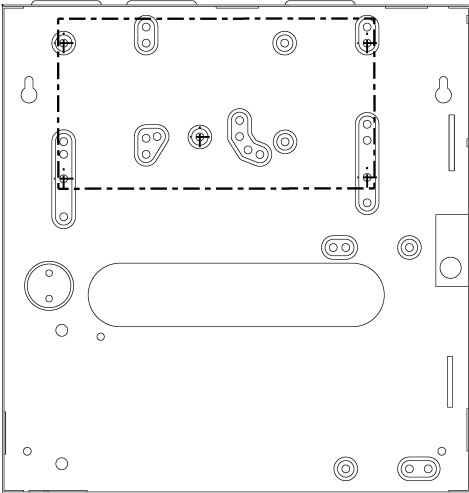

2.11 Auxiliary Power Terminals

The auxiliary power supply terminals can be used to power motion detectors, keypads and other modules or accessories in the security system. A fuseless circuit protects the power supply against current overload and automatically shuts down if the current exceeds 1.1A. If this occurs, the Maximum Auxiliary Current failure will appear in the keypad's trouble display (see *Trouble Display* on page 60). Therefore, the combined current consumption of devices connected to the auxiliary power supply should not exceed 700mA. If the auxiliary output is overloaded and is shut down, you must disconnect all loads from the output for at least 10 seconds before reconnecting any load back to the auxiliary output.

2.12 Telephone Line Connection

In order to report system events to the monitoring station, you must connect the incoming telephone company wires into the TIP and RING connections of the control panel and then run the wires from T1 and R1 to the telephone or telephone system as shown in PCB Layouts for each respective panel.

2.13 Bell Output Connection

The BELL+ and BELL- terminals power bells, sirens and other warning devices requiring a steady voltage output during an alarm. The bell output supplies 12Vdc upon alarm and can support one 30-watt or two 20-watt sirens. The bell output uses a fuseless circuit and will automatically shut down if the current exceeds 3A. When this occurs the Maximum Bell Current failure will only appear in the keypad's trouble display (see *Trouble Display* on page 60) during an alarm. If the load on the BELL terminals returns to normal, the control panel will re-instate power to the BELL terminals during the next alarm. When connecting sirens, please verify correct polarity. Connect the positive lead to the BELL+ terminal and the negative lead to the BELL- terminal of the control panel as shown in PCB Layouts for each respective panel.



If the BELL output is not being used, the Bell Disconnected failure will remain in the keypad's trouble display (see *Trouble Display* on page 60). To avoid this connect a 1KΩ resistor across the BELL terminals.



For connection of a self-contained bell/siren, see PCB Layouts for each respective panel.

2.14 Programmable Output Connections

When a specific event occurs in the system, a PGM can reset smoke detectors, activate strobe lights, open/close garage doors and much more.

2.14.1 PGMs

The control panels include two/four on-board programmable outputs (PGMs). For details on how to program PGMs, see *Programmable Outputs* on page 53. PGM1 and PGM2 can support up to 150mA. The PGMs are limited by the power source being used. If powered by:

- **The AUX terminals.** The current consumption of the AUX terminals cannot exceed 700mA. Therefore, whatever devices are connected to the AUX terminals (i.e. modules and PGMs) cannot exceed 700mA combined. For example, if there are six modules connected to the AUX terminals that are using 600mA and you wish to power the PGM using the AUX terminals, the PGM's current consumption cannot exceed 100mA.
- **An external power supply.** If using an external power supply, the current consumption cannot exceed 150mA for PGM1 and PGM2. If the external power supply's current consumption limit is less than that of the PGM it is connected to, then the current consumption will not exceed the power supply's current limit.



UL Note: The AUX terminals cannot exceed 200mA for UL installations.

Figure 2: Relay and PGM Connections

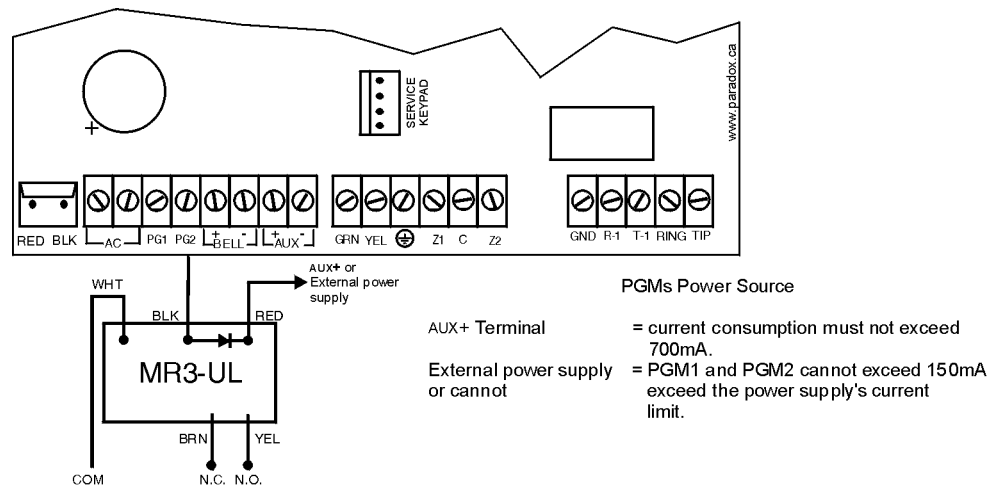

2.15 Single Zone Inputs

Detection devices such as motion detectors and door contacts are connected to the control panel's zone input terminals. Figure 3 demonstrates single zone input terminal connections recognized by the panel. Once connected, the associated zone's parameters must be defined.

Figure 3: Single Zone Input Connections

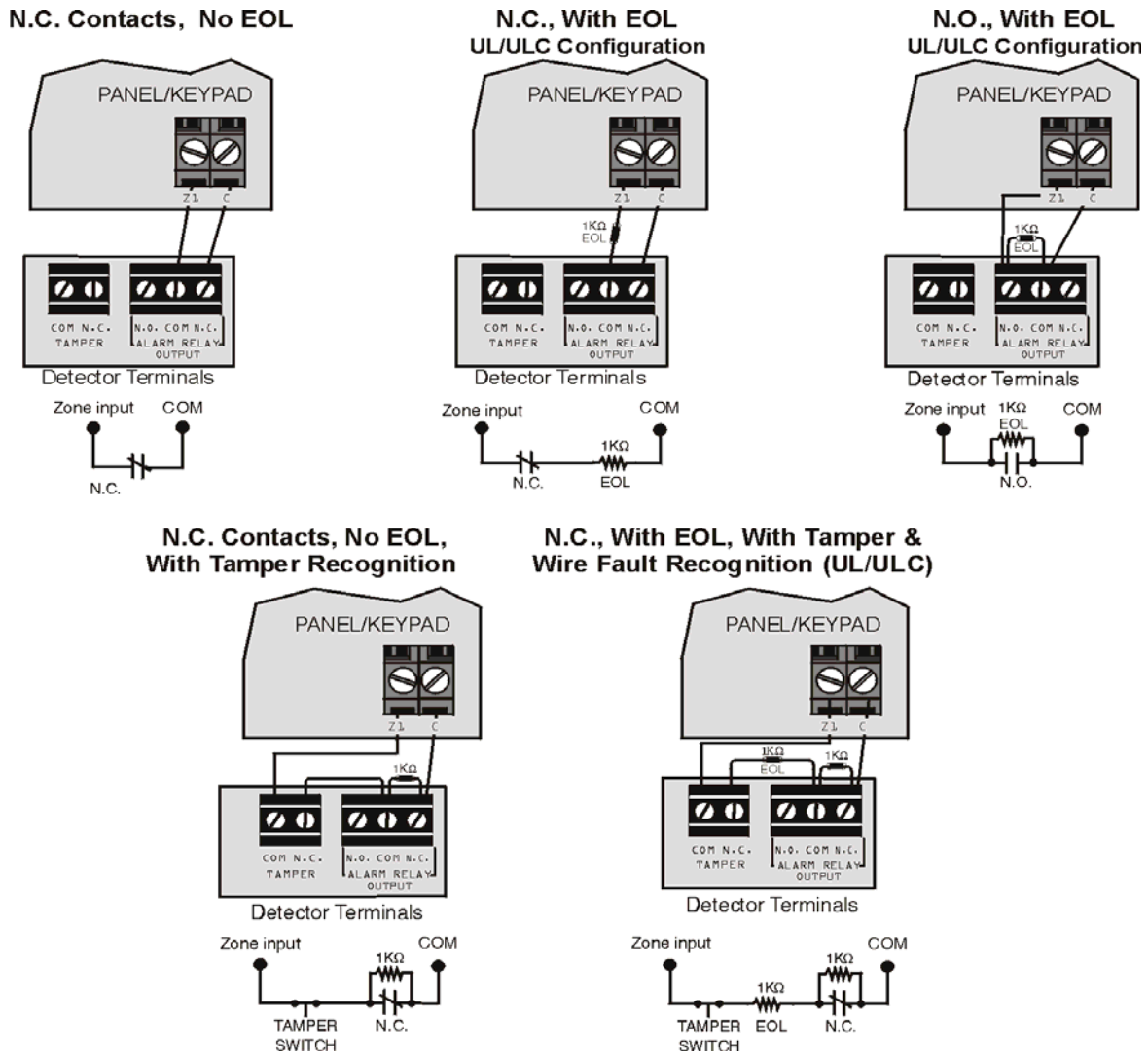

2.16 Advanced Technology Zone (ATZ) Connections

The ATZ feature is a software oriented feature that enables two detection devices to be installed per hardwired input terminal. Each detection device has its own zone, displays its zone status on the keypad and sends its own alarm codes. Fire zones cannot be doubled.

Figure 4: Advanced Technology Zone Connections

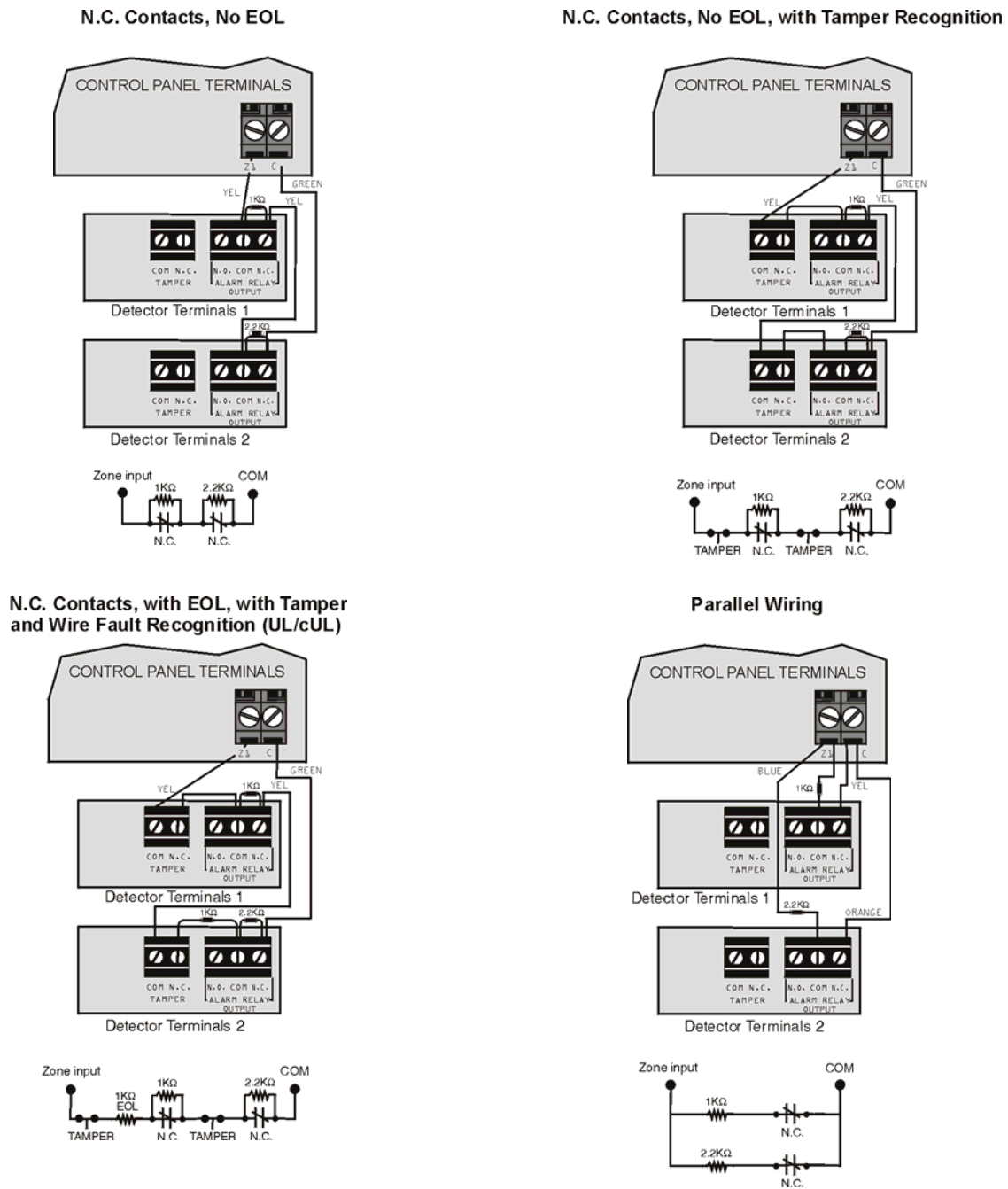

2.17 Fire Circuits

When a zone is programmed as a fire zone, the zone becomes normally open and requires an EOL resistor. If a line short occurs or if the smoke detector becomes active, whether the system is armed or disarmed, the control panel will generate an alarm. If a trouble occurs on a fire zone, the Fire Loop Trouble will appear in the keypad's trouble display (see *Trouble Display* on page 60) and the control panel can transmit the Fire Loop Trouble report, if programmed, in section [866].

Figure 5: Fire Circuits

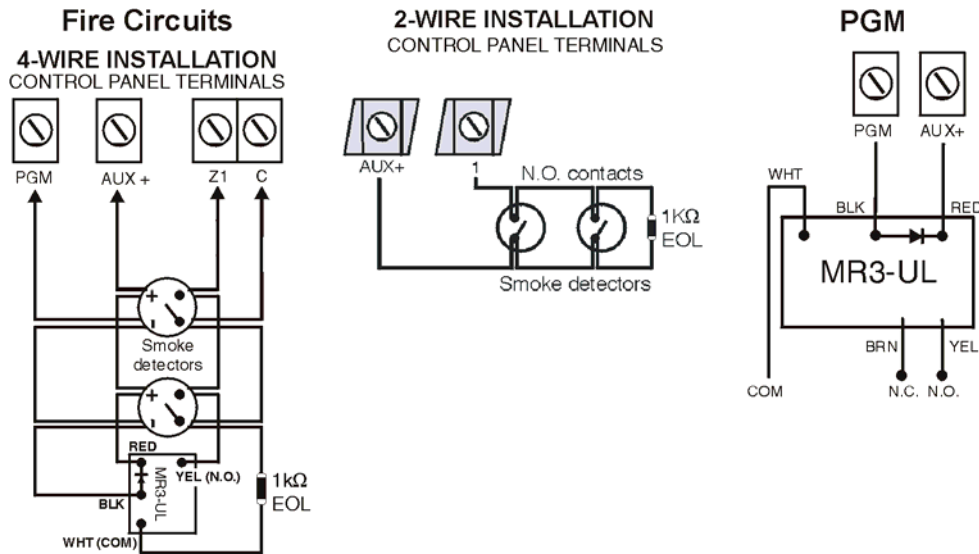

2.17.1 4-Wire and 2-Wire Installation:

For 4-wire installation, program the Activation Event so that the smoke detectors can be reset by pressing the [CLEAR] + [ENTER] keys for three seconds. See Event Group # 6 in the Event Description list in the programming guide.

For 2-wire smoke detector installation, connect the 2-wire smoke detectors. If a line short occurs or the smoke detector activates, whether the system is disarmed, the control panel will generate an alarm. If the line is open, the "Zone Fault" trouble indication appears on the trouble display and the report code is sent to the monitoring station, if programmed. To reset 2-wire smoke detectors, press the [CLEAR] + [ENTER] keys for three seconds.

Part 3: Programming Methods

3.1 WinLoad Software for Windows

Program the control panels remotely or on-site using the WinLoad Software (V2.80 or higher) for Windows®. For more information, contact your local Paradox Distributor or visit our web site at paradox.com. If you are using the WinLoad software, you must program the features (see *Settings for WinLoad Software* on page 58). Update the panel's firmware by connecting it to a PC via a 307 Direct Connect Interface and then using the Winload software. (Not investigated by UL).

3.2 Programming Using a Keypad

Use the supplied programming guide to keep track of which sections were programmed and how. We recommend you read the entire manual before you begin programming.

How Do I Enter Programming Mode?

- 1) Press **[ENTER]**
- 2) Enter your **[INSTALLER CODE]** (default: 0000 / 000000) or **[MAINTENANCE CODE]** (empty by default)
- 3) Enter 3-digit **[SECTION]** you wish to program
- 4) Enter required **[DATA]**

3.2.1 Single Digit Data Entry Method (Decimal and Hexadecimal)

Single Digit Data Entry is used in all sections except those specified in the Feature Select Programming Method (below). After entering Programming Mode as described in the shaded box above, some sections will require that you enter **Decimal** values from **000 to 255**. Other sections will require that you enter **Hexadecimal** values from **0 to F**. The required data will be clearly indicated in this manual as well as in the programming guide. When entering the final digit in a section, the control panel will automatically save and advance to the next section. Except sections 001 to 032, after entering the first three digits the control panel will switch to Feature Select Programming. For phone number programming, press **[ENTER]** to save the data.

Table 2: Decimal and Hexadecimal Programming Table

Value or Action	What Do I Press?	What Do I See?	
		32-zone LED	10-zone LED
Value 0 / Replace Current Digit with 0	[SLEEP]	Erase digit and remain in section	Erase digit and remain in section
Values 1 to 9	[1] to [9]	Zone 1 to 9	[1] to [9]
A (hex only)	[0]	Zone 10	[0]
B (hex only)	[OFF]	Zone 11	[OFF]
C (hex only)	[BYP]	Zone 12	[BYP]
D (hex only)	[MEM]	Zone 13	[MEM]
E (hex only)	[TBL]	Zone 14	[TBL]
F (hex only)	[⏻]	Zone 15	[⏻]
Exit Without Saving	[CLEAR]	ARM & STAY LED flash	ARM & STAY LED flash
Save Data (hex only)	[ENTER]	Advances to the next section	Advances to the next section

3.2.2 Feature Select Programming Method

After entering certain sections, eight options will be displayed where each option from **[1]** to **[8]** represents a specific feature. Press the key corresponding to the desired option. This means the option is ON. Press the key again to remove the digit, thereby, turning OFF the option. When the options are set, press the **[ENTER]** key to save and advance to the next section.

3.2.3 Data Display Mode (except MG32LCD)

In the Data Display Mode you can view the programmed contents of each section one digit at a time.

Figure 6: Data Display Mode

To access the Data Display Mode, press the **[ENTER]** key after entering a section and before entering any data. The four LEDs as indicated below will begin to flash indicating that you are in the Data Display Mode.



Each time the **[ENTER]** key is pressed, the keypad will display the next digit in the current section and will continue through all the following sections one digit at a time without changing the programmed values. Not available for sections using the Multiple Feature Select Method. Press the **[CLEAR]** key at any time to exit the Data Display Mode.

3.3 Configuring the Keypad Zone Number

How Do I Configure The Keypad?

Press **[ENTER]**

Enter your **[INSTALLER CODE]** (default: 0000 / 000000) or **[MAINTENANCE CODE]** (empty by default)

Press **[⏻]** and hold for three seconds

Enter the desired zone number key (MG32LED/MG32LCD: 2-digit entry 01 to 32, MG10LEDV/H: 1-digit entry 1 to 0(10))

Press **[ENTER]** to save and exit programming mode

Press **[CLEAR]** to erase data without saving

Press **[CLEAR]+[CLEAR]** to exit programming mode without saving

⚠ PLEASE NOTE: After five minutes, the keypad exits programming mode.

3.4 Programming Using A Paradox Memory Key*

Copy the sections of one control panel into the Paradox Memory Key (PMC-4/PMC5). Then copy the contents of the Memory Key into as many control panels as needed. Each panel is programmed in less than 3 seconds.

Download to DESTINATION Control Panel or module

- 1) Remove AC and battery power from the control panel.
- 2) Place the Memory Key on the serial connector labeled MEMORY KEY of the Control Panel that is to receive the contents of the Memory Key.
- 3) Reapply AC and battery power.
- 4) In Installer Programming Mode, enter section **[970]**, the keypad emits a confirmation beep.
- 5) When the keypad emits a second confirmation beep, remove the Memory Key.

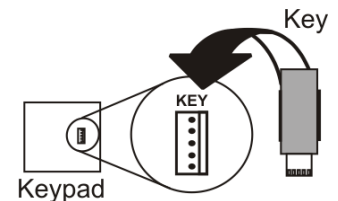

Copy to Memory Key from SOURCE Control Panel or module

- 1) Remove AC and battery power from the control panel.
- 2) Place Memory Key on the serial connector labeled MEMORY KEY of the Control Panel that you want to copy. Make sure the write protect jumper of the Memory Key is on.
- 3) Reapply AC and battery power.
- 4) In Installer Programming Mode, enter section **[975]**. The keypad emits a confirmation beep.
- 5) After the keypad emits a second confirmation beep, remove the Memory Key. Remove the Memory Key's jumper if you do not wish to accidentally overwrite its contents.

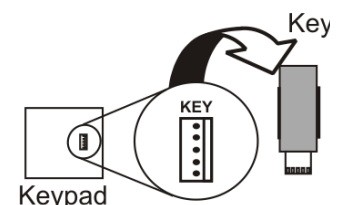

* Not investigated by UL

Figure 7: Paradox Memory Key

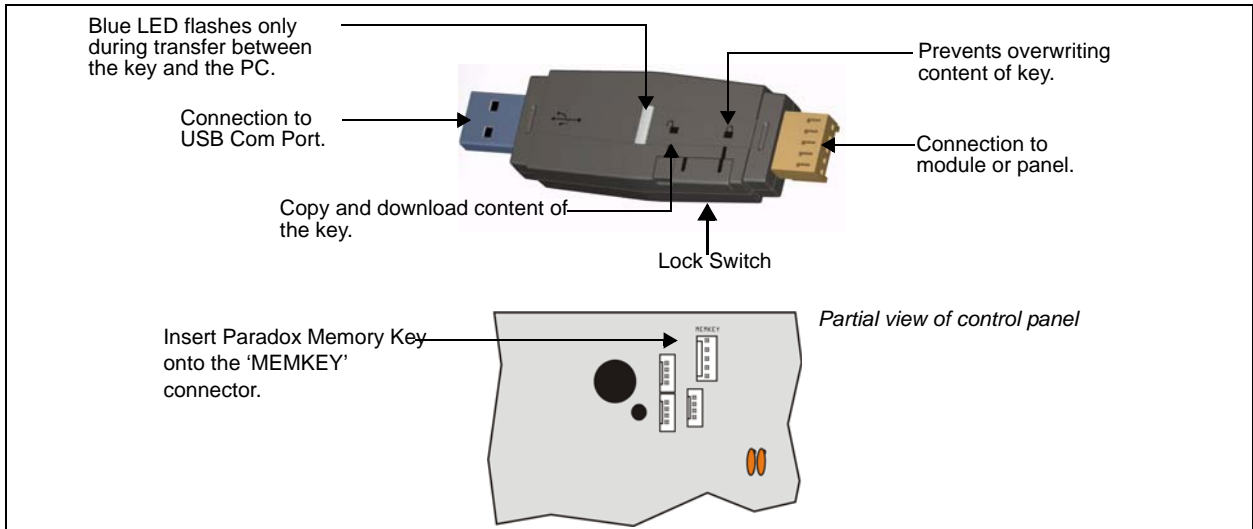

Part 4: LCD Keypad Labels

4.1 Input Keys

Special Function Keys		Alphanumeric Key Input	
Key	Function	[1]	A / B / C
[STAY]	Insert space	[2]	D / E / F
[SLEEP]	Delete	[3]	G / H / I
[ARM]	Delete whole entry	[4]	J / K / L
[OFF]	Toggle numeric/alphanumeric keys	[5]	M / N / O
[BYP]	Toggle lower case/upper case	[6]	P / Q / R
[MEM]	Special characters	[7]	S / T / U
		[8]	V / W / X
		[9]	Y / Z

4.2 Label Sections

Label Sections	
[181] to [212]	32 Zone Labels
[341] to [356]	16 PGM Labels
[511] to [542]	32 User Labels
[771] to [772]	2 Partition Labels
[568] to [569]	2 Wireless Labels
[599] to [606]	8 Wireless Keypads
[781] to [795]	15 Bus Modules Labels

4.3 Special Characters and Keypad Letter Assignment

Polish / Hungarian / Turkish Special Character Catalogue

Polish	⁰⁰¹ Ẑ	⁰⁰² Ć	⁰⁰³ ą	⁰⁰⁴ ę	⁰⁰⁵ ż	⁰⁰⁶ ł	⁰⁰⁷ ś
Hungarian	⁰⁰¹ Á	⁰⁰² Ű	⁰⁰³ Ő				
Turkish	⁰⁰¹ ü						

Special Character Catalogue

⁰³²	⁰⁴⁸ Ø	⁰⁶⁴ @	⁰⁸⁰ P	⁰⁹⁶ `	¹¹² p	¹²⁸ Û	¹⁴⁴ Ê	¹⁶⁰ à	¹⁷⁶ §	¹⁹² Ø	²⁰⁸ •
⁰³³ !	⁰⁴⁹ 1	⁰⁶⁵ A	⁰⁸¹ Q	⁰⁹⁷ a	¹¹³ q	¹²⁹ Û	¹⁴⁵ È	¹⁶¹ î	¹⁷⁷ ±	¹⁹³ L	²⁰⁹ "
⁰³⁴ "	⁰⁵⁰ 2	⁰⁶⁶ B	⁰⁸² R	⁰⁹⁸ b	¹¹⁴ r	¹³⁰ Ú	¹⁴⁶ É	¹⁶² ï	¹⁷⁸ ïj	¹⁹⁴ Đ	²¹⁰ °
⁰³⁵ #	⁰⁵¹ 3	⁰⁶⁷ C	⁰⁸³ S	⁰⁹⁹ c	¹¹⁵ s	¹³¹ Û	¹⁴⁷ Ê	¹⁶³ í	¹⁷⁹ ↑	¹⁹⁵ ß	²¹¹ `
⁰³⁶ \$	⁰⁵² 4	⁰⁶⁸ D	⁰⁸⁴ T	¹⁰⁰ d	¹¹⁶ t	¹³² Û	¹⁴⁸ ê	¹⁶⁴ ï	¹⁸⁰ ↓	¹⁹⁶ ç	²¹² ´
⁰³⁷ %	⁰⁵³ 5	⁰⁶⁹ E	⁰⁸⁵ U	¹⁰¹ e	¹¹⁷ u	¹³³ Û	¹⁴⁹ è	¹⁶⁵ i	¹⁸¹ ↵	¹⁹⁷ ®	²¹³ ~
⁰³⁸ &	⁰⁵⁴ 6	⁰⁷⁰ F	⁰⁸⁶ V	¹⁰² f	¹¹⁸ v	¹³⁴ ú	¹⁵⁰ é	¹⁶⁶ Ñ	¹⁸² f	¹⁹⁸ □	²¹⁴ ÷
⁰³⁹ '	⁰⁵⁵ 7	⁰⁷¹ G	⁰⁸⁷ W	¹⁰³ g	¹¹⁹ w	¹³⁵ Ô	¹⁵¹ ë	¹⁶⁷ ñ	¹⁸³ £	¹⁹⁹ □	²¹⁵ «
⁰⁴⁰ (⁰⁵⁶ 8	⁰⁷² H	⁰⁸⁸ X	¹⁰⁴ h	¹²⁰ x	¹³⁶ Ò	¹⁵² À	¹⁶⁸ Ñ	¹⁸⁴ →	²⁰⁰ μ	²¹⁶ »
⁰⁴¹)	⁰⁵⁷ 9	⁰⁷³ I	⁰⁸⁹ Y	¹⁰⁵ i	¹²¹ y	¹³⁷ Ó	¹⁵³ Ä	¹⁶⁹ Ź	¹⁸⁵ ↓	²⁰¹ Ø	²¹⁷ †
⁰⁴² *	⁰⁵⁸ :	⁰⁷⁴ J	⁰⁹⁰ Z	¹⁰⁶ j	¹²² z	¹³⁸ Ω	¹⁵⁴ à	¹⁷⁰ 9	¹⁸⁶ ↑	²⁰² ŷ	²¹⁸ \
⁰⁴³ +	⁰⁵⁹ ;	⁰⁷⁵ K	⁰⁹¹ [¹⁰⁷ k	¹²³ {	¹³⁹ ò	¹⁵⁵ â	¹⁷¹ v	¹⁸⁷ ↓	²⁰³ Æ	²¹⁹ x
⁰⁴⁴ ,	⁰⁶⁰ <	⁰⁷⁶ L	⁰⁹² ¥	¹⁰⁸ l	¹²⁴	¹⁴⁰ ò	¹⁵⁶ à	¹⁷² √	¹⁸⁸ ¶	²⁰⁴ ¢	²²⁰ ©
⁰⁴⁵ -	⁰⁶¹ =	⁰⁷⁷ M	⁰⁹³]	¹⁰⁹ m	¹²⁵ }	¹⁴¹ ó	¹⁵⁷ á	¹⁷³ w	¹⁸⁹ ½	²⁰⁵ ā	²²¹ ©
⁰⁴⁶ .	⁰⁶² >	⁰⁷⁸ N	⁰⁹⁴ ^	¹¹⁰ n	¹²⁶ →	¹⁴² ô	¹⁵⁸ ä	¹⁷⁴ ω	¹⁹⁰ ¼	²⁰⁶ Õ	²²² ☐
⁰⁴⁷ /	⁰⁶³ ?	⁰⁷⁹ O	⁰⁹⁵ _	¹¹¹ o	¹²⁷ ←	¹⁴³ ç	¹⁵⁹ Å	¹⁷⁵ Æ	¹⁹¹ ¼	²⁰⁷ Ö	²²³ ☐

Hebrew Keypad Letter Assignment

Key	Press key once	Press key twice	Press key three times
[1]	א	ב	ג
[2]	ד	ה	ו
[3]	ז	ח	ט
[4]	י	כ	ל
[5]	מ	נ	ס
[6]	ע	פ	צ
[7]	ק	ר	ש
[8]	ת		
[9]			

Hebrew Special Characters Catalogue

032	048	064	080	096	112	160	176	192	208	224	240
	0	י	פ	ץ	ך	ח	ט	ז	ו	ה	ד
033	049	065	081	097	113	161	177	193	209	225	241
!	1	א	ק	ב	ג	ד	ה	ו	ז	ח	ט
034	050	066	082	098	114	162	178	194	210	226	242
"	2	ב	ר	ב	ר	א	ב	ג	ד	ע	ו
035	051	067	083	099	115	163	179	195	211	227	243
#	3	כ	ס	כ	ס	ט	י	י	י	י	י
036	052	068	084	100	116	164	180	196	212	228	244
φ	4	ד	ט	ד	ט	ה	ו	ו	ו	ו	ו
037	053	069	085	101	117	165	181	197	213	229	245
%	5	ע	ו	ע	ו	ז	ח	ח	ח	ח	ח
038	054	070	086	102	118	166	182	198	214	230	246
&	6	פ	ו	פ	ו	ז	ח	ח	ח	ח	ח
039	055	071	087	103	119	167	183	199	215	231	247
'	7	ג	ו	ג	ו	ז	ח	ח	ח	ח	ח
040	056	072	088	104	120	168	184	200	216	232	248
<	8	ח	ח	ח	ח	ח	ח	ח	ח	ח	ח
041	057	073	089	105	121	169	185	201	217	233	249
>	9	י	י	י	י	י	י	י	י	י	י
042	058	074	090	106	122	170	186	202	218	234	250
*	:	י	י	י	י	י	י	י	י	י	י
043	059	075	091	107	123	171	187	203	219	235	251
+	Γ	כ	ש	כ	ז	ז	ז	ז	ז	ז	ז
044	060	076	092	108	124	172	188	204	220	236	252
'	<	ל	ל	ל	ל	ל	ל	ל	ל	ל	ל
045	061	077	093	109	125	173	189	205	221	237	253
-	=	מ	ש	ז	ז	ז	ז	ז	ז	ז	ז
046	062	078	094	110	126	174	190	206	222	238	254
□	>	נ	ח	ח	ח	ח	ח	ח	ח	ח	ח
047	063	079	095	111	127	175	191	207	223	239	255
/	ד	ו	ש	ו	ז	ז	ז	ז	ז	ז	ז

Greek Keypad Letter Assignment

Key	Press key once	Press key twice	Press key three times
[1]	A	B	Γ
[2]	Δ	E	Z
[3]	H	Θ	I
[4]	K	Λ	M
[5]	N	Ξ	O
[6]	Π	P	Σ
[7]	T	Υ	Φ
[8]	X	Ψ	Ω

Greek Special Characters Catalogue

016	032	048	064	080	096	112	128	144	160	176	192	208	224	240
±	0	α	β	γ	δ	ε	ζ	η	θ	ι	κ	λ	μ	ν
017	033	049	065	081	097	113	129	145	161	177	193	209	225	241
≡	1	Α	Β	Γ	Δ	Ε	Ζ	Η	Θ	Ι	Κ	Λ	Μ	Ν
018	034	050	066	082	098	114	130	146	162	178	194	210	226	242
∂	"	2	Β	Ρ	β	ρ	α	β	γ	δ	ε	ζ	η	θ
019	035	051	067	083	099	115	131	147	163	179	195	211	227	243
∫	#	3	Κ	Σ	κ	σ	α	β	γ	δ	ε	ζ	η	θ
020	036	052	068	084	100	116	132	148	164	180	196	212	228	244
∫	\$	4	Δ	Τ	δ	τ	α	β	γ	δ	ε	ζ	η	θ
021	037	053	069	085	101	117	133	149	165	181	197	213	229	245
∫	%	5	Ε	Υ	ε	υ	α	β	γ	δ	ε	ζ	η	θ
022	038	054	070	086	102	118	134	150	166	182	198	214	230	246
∫	&	6	Φ	Υ	φ	υ	α	β	γ	δ	ε	ζ	η	θ
023	039	055	071	087	103	119	135	151	167	183	199	215	231	247
∫	'	7	Γ	Ψ	γ	ψ	α	β	γ	δ	ε	ζ	η	θ
024	040	056	072	088	104	120	136	152	168	184	200	216	232	248
∫	<	8	Χ	Χ	χ	χ	α	β	γ	δ	ε	ζ	η	θ
025	041	057	073	089	105	121	137	153	169	185	201	217	233	249
∫	>	9	Υ	Υ	υ	υ	α	β	γ	δ	ε	ζ	η	θ
026	042	058	074	090	106	122	138	154	170	186	202	218	234	250
∫	*	:	Ι	Ζ	ι	ζ	α	β	γ	δ	ε	ζ	η	θ
027	043	059	075	091	107	123	139	155	171	187	203	219	235	251
∫	+	;	Κ	Λ	κ	λ	α	β	γ	δ	ε	ζ	η	θ
028	044	060	076	092	108	124	140	156	172	188	204	220	236	252
∫	<	∫	∫	∫	∫	∫	∫	∫	∫	∫	∫	∫	∫	∫
029	045	061	077	093	109	125	141	157	173	189	205	221	237	253
∫	-	=	Μ	Ξ	μ	ξ	α	β	γ	δ	ε	ζ	η	θ
030	046	062	078	094	110	126	142	158	174	190	206	222	238	254
∫	□	>	Ν	Χ	ν	χ	α	β	γ	δ	ε	ζ	η	θ
031	047	063	079	095	111	127	143	159	175	191	207	223	239	255
∫	/	∫	∫	∫	∫	∫	∫	∫	∫	∫	∫	∫	∫	∫

Russian Keypad Letter Assignment

Key	Press key once	Press key twice	Press key three times	Press key four times
[1]	А	Б	В	Г
[2]	Д	Е	Ё	Ж
[3]	З	И	Й	К
[4]	Л	М	Н	О
[5]	П	Р	С	Т
[6]	У	Ф	Х	Ц
[7]	Ч	Ш	Щ	Ъ
[8]	Ы	Ь	Э	Ю
[9]	Я			

Russian Special Characters Catalogue

032	048	064	080	096	112	128	144	160	176	192	208	224	240
	0	Ð	Р	`	р			Б	Ю	Ч		Д	¼
033	049	065	081	097	113	129	145	161	177	193	209	225	241
!	1	А	Q	a	q			Г	Я	ш		Ц	1/3
034	050	066	082	098	114	130	146	162	178	194	210	226	242
"	2	В	R	b	г			Ё	б	ъ		Ш	1/2
035	051	067	083	099	115	131	147	163	179	195	211	227	243
#	3	С	S	c	s			Ж	В	ы	!!	Д	
036	052	068	084	100	116	132	148	164	180	196	212	228	244
\$	4	D	T	d	t			З	Г	ь		Ф	
037	053	069	085	101	117	133	149	165	181	197	213	229	245
%	5	E	U	e	u			И	ё	э		Ш	
038	054	070	086	102	118	134	150	166	182	198	214	230	246
&	6	F	V	f	v			Й	ж	ю		Щ	
039	055	071	087	103	119	135	151	167	183	199	215	231	247
'	7	G	W	g	w			Л	з	я	!	'	
040	056	072	088	104	120	136	152	168	184	200	216	232	248
(8	H	X	h	x			П	и	«		••	
041	057	073	089	105	121	137	153	169	185	201	217	233	249
)	9	I	Y	i	y			У	й	»	↑	~	
042	058	074	090	106	122	138	154	170	186	202	218	234	250
*	:	J	Z	j	z			Ф	к	„	↓	é	
043	059	075	091	107	123	139	155	171	187	203	219	235	251
+	;	K	[k	10			Ч	л	“		ç	
044	060	076	092	108	124	140	156	172	188	204	220	236	252
,	<	L	ç	l	12			Ш	М			ij	
045	061	077	093	109	125	141	157	173	189	205	221	237	253
-	=	M]	m	15			Ъ	п	ć		☼	§
046	062	078	094	110	126	142	158	174	190	206	222	238	254
•	>	N	^	n	←			Ы	п	f			¶
047	063	079	095	111	127	143	159	175	191	207	223	239	255
/	?	O	_	o				Э	т	£	■	○	

Part 5: Access Codes

The control panel supports the following access codes:

Installer Code [397]:	Used to program all control panel settings except user access codes.
Maintenance Code [398]:	The Maintenance code is similar to the Installer code. It can be used to enter programming mode, which allows you to program all the features, options and commands except for the panel's communication settings. The maintenance code is empty by default.
System Master Code [399]:	Provides full access. Arm and disarm using any method described in the <i>User Code Options</i> below as well as program the user access codes.
Master Code 1:	Permanently assigned to partition 1. Same as a regular user code except it can also program access codes for user codes assigned to partition 1.
Master Code 2:	Permanently assigned to partition 2. Same as a regular user code except it can program access codes for user codes assigned to partition 2. If the system is not partitioned Master Code 2 will be assigned to partition 1.
29 User Codes:	Can arm and disarm as per User Code Options on page 21.

5.1 Access Code Length

Section [701]: System Options

Option [1] OFF = 6-Digit Access Codes

Option [1] ON = 4-Digit Access Codes (default)

All access codes can be set to lengths of either 4- or 6-digits. When the 4-digit option is selected, entering a 4-digit code will allow access. Using the 6-digit option, entering 6 digits is required to allow access.



If the access code length is changed from four digits to six digits when access codes have already been programmed, the control panel will automatically add the last 2 digits by using the first 2 digits. For example, if the access code is 1234 and you switch to 6 digits, the code will become 123412. Be sure to verify the access codes after switching from 4-digit access codes to 6-digit codes. When switching from six digits to four digits, the control panel will simply remove the final two digits of the access code. For example, 123456 will become 1234.

5.2 Installer Code (Default: 0000 / 000000)

The Installer Code is used to enter the system's programming mode, which allows you to program all the features, options and commands of the control panel. The Installer Code can be 4- or 6-digits in length (see *Access Code Length* on page 21) where each digit can be any value from 0 to 9. The Installer Code cannot be used to program Master Code 1, Master Code 2 or user access codes. To program the Installer Code press:

[ENTER]+ [CURRENT INSTALLER CODE] + [397] + *new 4- or 6-digit Installer Code*

5.3 Maintenance Code (Default: Empty)

The Maintenance code is similar to the Installer code. It can be used to enter programming mode, which allows you to program all the features, options and commands **except** for the system's communication settings (sections [395], [397], [398], [815], [816], [817], [910], and [911]) as well as any user codes. The Maintenance code can be 4 or 6 digits in length where each digit can be any value from 0 to 9. The Maintenance code is empty by default. Set the Maintenance in section [398].

[ENTER]+ [INSTALLER CODE] + [398] + *new 4- or 6-digit Maintenance Code*

5.4 System Master Code (Default: 1234 / 123456)

The Installer Code can be used to program the System Master Code. With the System Master Code a user can use any arming method and can program any user access code, but not the User Code Options. The System Master Code can be 4 or 6 digits in length, where each digit can be any digit from 0 to 9. The System Master Code can be modified but cannot be erased. To change the System Master Code press:

[ENTER]+ [INSTALLER CODE] + [399] + *new 4- or 6-digit System Master Code*

5.5 User Code Options

Sections [404] to [432]: Options [1] to [8]

The User Code Options define which arming methods each user can use to arm or disarm the system. Regardless of these settings, all users can Regular arm assigned partitions and all users except those with the Arm Only option can disarm an assigned partition, regardless of how it is armed. Select one or more of the options described on the following pages for each user access code, where sections [404] to [432] represent user access codes 004 to 032.

5.5.1 Partition 1 Assignment

Sections [404] to [432]: User codes 004 to 032

Option [1] OFF = Deny access to partition 1

Option [1] ON = User code has access to partition 1 (default)

If the system is partitioned (see *Partitioning* on page 55), user codes with this option enabled can arm and disarm partition 1.



If the system is not partitioned, you must assign partition 1 to the user access code. Otherwise, the user access code will be considered disabled.

5.5.2 Partition 2 Assignment

Sections [404] to [432]: User Codes 004 to 032
Option [2] OFF = Deny access to partition 2 (default)
Option [2] ON = User code has access to partition 2

If the system is partitioned (see *Partitioning* on page 55), user codes with this option enabled can arm and disarm partition 2. If the system is not partitioned, the control panel ignores this option.

5.5.3 Bypass Programming

Sections [404] to [432]: User Codes 004 to 032
Option [3] OFF = Bypass Programming Disabled
Option [3] ON = Bypass Programming Enabled (default)

User codes with this option enabled can perform Bypass Programming in assigned partitions.

5.5.4 Stay/Sleep Arming

Sections [404] to [432]: User Codes 004 to 032
Option [4] OFF = Stay/Sleep Arming Disabled
Option [4] ON = Stay/Sleep Arming Enabled for selected User Code (default)

User codes with this option enabled can Stay or Sleep arm assigned partitions.

5.5.5 Force Arming

Sections [404] to [432]: User Codes 004 to 032
Option [5] OFF = Force Arming Disabled
Option [5] ON = Force Arming Enabled for selected User Code (default)

User codes with this option enabled can Force arm assigned partitions.

5.5.6 Arm Only

Sections [404] to [432]: User Codes 004 to 032
Option [6] OFF = Arm Only Disabled (default)
Option [6] ON = Arm Only Enabled for selected User Code

The user code with this option enabled can arm assigned partitions, but cannot disarm any partitions. The type of arming is dependent on the other User Code Options selected. Please note that with the Arm Only option, the user can cancel a recently armed system by re-entering the access code before the end of the exit delay.

5.5.7 PGM Activation

Sections [404] to [432]: User Codes 004 to 048
Option [7] OFF = User Code follows User Code Options and can activate a PGM (default)
Option [7] ON = User Code can activate a PGM only

With option [7] off, entering the access code will arm or disarm according to the programmed User Code Options as well as activate or deactivate a PGM. The appropriate PGM Activation/Deactivation Event must also be programmed (see *Programmable Outputs* on page 53). With option [7] on, the control panel will ignore all other User Code Options. Therefore, entering the access code will only activate or deactivate the PGM.

5.5.8 Duress

Sections [404] to [432]: User Codes 004 to 032
Option [8] OFF = User Code with duress disabled (default)
Option [8] ON = User Code with duress enabled

If you are coerced into arming or disarming your system, entering the access code with the duress option enabled will arm or disarm the system and immediately transmit a silent alert (Duress Code) to the monitoring station.

5.6 Lock Master Code

Section [701]: System Options
Option [2] OFF = Lock System Master Code Disabled (default)
Option [2] ON = Lock System Master Code Enabled

With this feature enabled, the control panel will lock the System Master Code (001), it cannot be modified. With this feature disabled, the control panel will unlock the System Master Code, so that it can be changed. The System Master Code cannot be deleted (see Master Quick Menu Programming in the User Guide).

Part 6: StayD Mode

6.1 Overview

- **NOTE: StayD is automatically enabled when a path is programmed to a keypad. When deleting a wireless keypad (MG32LRF) from the system, the corresponding path zones will also be deleted.** StayD simplifies your life and makes it safer by protecting you 24 hours a day, 7 days a week without ever having to disarm the system - even when entering an armed area. StayD lives with you and protects you at all times, without any unprotected periods, and while automatically rearming the system so you don't have to remember to do it. This unique feature integrates security into your everyday life to give you safe, simple living with peace of mind.



6.2 Entry/Exit Paths

- StayD consists of programmed pathways, where the user enters and exits the property through pre-defined routes, with only the route's respective zones open for passage. A path can be programmed for each individual keypad, with a maximum of four zones per path. Path zones must be defined as follow or delay zones only. StayD is automatically enabled when a path is programmed to a keypad.
- The first zone programmed in a path is its designated entry point (e.g. doors, garage). Designated entry points are not common to multiple paths. There is only one designated entry point per path. Also, they are only used when entering/exiting with a remote control (see below).
- The system only disables the path zones corresponding to the keypad at the point of entry/exit, while re-arming as you enter/exit.
- If another path zone opens before trying to disarm the system, you can validate the zone by entering your user code. For example, you have entered your home through Path 1 and are at your keypad. Before disarming the system, you notice a Path 2 zone has opened. If you know it is a member of your family and would like to validate the open zone, enter your user code. All paths, including Path 1, will subsequently be validated. If the path 2 zone opens after you have entered your code to validate Path 1, you must enter your code again to validate Path 2.
- You must enter your code for every zone that opens that is not part of any path. For example, if you have entered through Path 1 and a non-path zone opens, you must enter your code once to validate your path and once for the non-path zone. If you do not validate the non-path zone, the system will fall in alarm.

6.3 Entry/Exit with a Keypad

- When entering with a keypad, the path zones will fall into entry delay, allowing you to reach the keypad. Use the keypad to disarm the system and switch to Stay arm mode.
- When exiting with a keypad, only the path zones will fall into delay (same as exit delay), allowing you to leave while the rest of the premises remains secure.

6.4 Entry/Exit with a Remote Control

- When using a remote control, the path you use is defined by a designated entry point. For example: if after pressing the remote control to disarm the system you trigger zone 1, the system will check to see which path(s) include zone 1. All paths that include zone 1 will open. Only after reaching the designated entry point will the system know which path you are taking, and thus will re-arm all other paths. After entry with a remote, the system will automatically arm in Stay mode.
- To disarm the system with a remote control: Press  once to disarm partition 1, twice for partition 2, and three times for both partitions. Press the  button four times to cancel the exit delay and arm the system in Stay mode.

6.5 Window Mode and Re-arm Delay

- In a Stay-armed system: This mode allows you to open one exterior zone without triggering an alarm. To enter Window mode, press [OFF], then your [ACCESS CODE]. All zones that can be opened flash. The system will start an exit delay, allowing you to open an exterior zone such as a window or a door. The system will only allow you to open one zone as the exit delay will end after doing so. When you close the open zone (window, door, etc.) that zone will re-arm.
- Re-arm Delay is a delay timer set so that when you close the open exterior zone (window, door etc.), it does not re-arm instantly. Instead the system starts the delay to allow you to close the zone properly. The delay will start every time you open the zone while trying to close it, and you must close the zone for 5 seconds for it to arm. This is especially useful for eliminating false alarms caused by windows that stick.

6.6 Advanced Settings

Section	Data		Description
[720]	__/__/__	(000 to 255) sec.	Flex-Instant = Instant and follow zones will follow the delay at section [720] when Stay or Sleep armed (default is 15 seconds / 000 = instant zone).

Section	Data		Description
[721]	__/__/__	(000 to 255) sec.	Re-arm delay (delay before zone re-arms). Default = 000 (no delay)

Part 7: Zone Programming

When programming zones, the zone assignments are dependent on the designation of the wireless transmitters, assignment of keypad zones, and the detection devices that are connected to the panel. For wireless assignment, see *Wireless Transmitter Programming* on page 32 or the Installer Quick Menu of the programming guide. For keypad assignment, see *Configuring the Keypad Zone Number* on page 16. After assigning the required zones, you must set the zone's definitions, partition assignment, and options see Figure 8 below. Certain Zone Definitions change if a Flex-Instant delay is activated (section [720]). See *Zone Definition Status* on page 28.

Table 3: Zone Recognition Table

	Wireless	Keypad	Hardwire
Zone 1	Yes	Yes	Yes (Input Z1)
Zone 2	Yes	Yes	Yes (Input Z2)
Zone 3	Yes	Yes	Yes (Input Z1 with ATZ)
Zone 4	Yes	Yes	Yes (Input Z2 with ATZ)
Zone 5 to 32	Yes	Yes	No



If a zone is already programmed and you assign a device to the same zone, a wireless zone will overwrite a keypad/hardwire zone, and a keypad zone will overwrite a hardwire zone.

Figure 8: Zone Programming

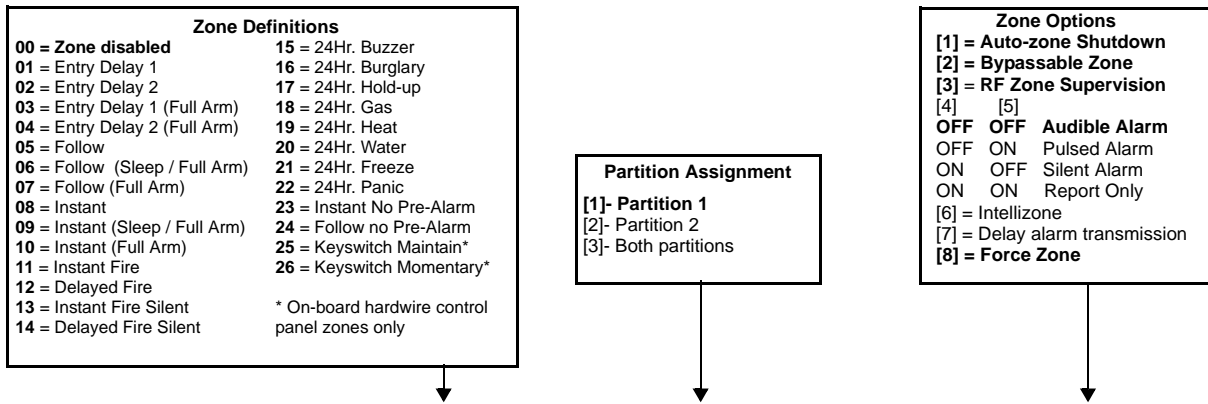

Section	Zone Definition	Partition Assignment	Zone Options
[001] = Zone 1	___/___	_____	1 2 3 4 5 6 7 8
[032] = Zone 32	___/___	_____	1 2 3 4 5 6 7 8

7.1 Zone Definitions

As demonstrated in Figure 8 above, sections [001] to [032] represent zones 1 through 32 respectively, where the first two digits in each of these sections represents the zone's definition. To disable a zone, enter [00]. There are 26 available Zone Definitions.

7.1.1 Entry Delay 1 Zones

Sections [001] to [032]: Zones 1 to 32, First Digits = 01

When the system is armed and a zone defined with Entry Delay 1 opens, the control panel will generate an alarm after the programmed Entry Delay 1 Timer elapses. This is to provide users with enough time to enter the protected area and disarm the system. To program the Entry Delay 1 Timer, key in the desired 3-digit delay value (000 to 255 seconds, Default = 45 seconds) into section [710]. Entry delay zones are commonly used at the entry/exit points of the protected area (i.e. front/back door, garage, etc.). Using different entry delays is useful when, for example, one entry point requires a longer delay than the other entry point or in a partitioned system where each partition may require a different entry delay.

7.1.2 Entry Delay 2 Zones

Sections [001] to [032]: Zones 1 to 32, First Digits = 02

Entry Delay 2 zones are identical to the Entry Delay 1 zones, except it uses a separate entry delay timer. To program the Entry Delay 2 Timer, key in the desired 3-digit delay value (000 to 255 seconds, Default = 45 seconds) into section [711].

7.1.3 **Entry Delay 1 (Full Arm) Zones**

Sections **[001]** to **[032]**: Zones 1 to 32, First Digits = **03**

Upon regular arming, the zone is Entry Delay 1 (see *Entry Delay 1 Zones* on page 24). Upon Stay/Sleep arming, the zone is bypassed by the system. See Zone Definition Status on page 28 for any exceptions.

7.1.4 **Entry Delay 2 (Full Arm) Zones**

Sections **[001]** to **[032]**: Zones 1 to 32, First Digits = **04**

Upon regular arming, the zone is Entry Delay 2 (see *Entry Delay 2 Zones* on page 24). Upon Stay/Sleep arming, the zone is bypassed by the system. See Zone Definition Status on page 28 for any exceptions.

7.1.5 **Follow Zones**

Sections **[001]** to **[032]**: Zones 1 to 32, First Digits = **05**

When a Regular, Stay, or Sleep armed Follow Zone opens, the control panel will immediately generate an alarm, unless an entry delay zone opens first:

- If a Regular/Stay/Sleep armed Follow Zone opens after an entry delay zone opens, the control panel waits until the entry delay timer has elapsed before generating an alarm.
- If a Regular/Stay/Sleep armed Follow Zone opens after more than one entry delay zone opens, the control panel will wait until the entry delay timer of the zone that opened first has elapsed.

This feature is commonly used when a motion detector is protecting the area occupied by the entry point keypad. This will prevent the motion detector from causing an alarm when a user enters through the entry point to disarm the system. See Zone Definition Status on page 28 for any exceptions.

7.1.6 **Follow (Sleep / Full Arm)**

Sections **[001]** to **[032]**: Zones 1 to 32, First Digits = **06**

Upon regular arming or sleep arming, the zone is Follow. Upon Stay arming, the zone is bypassed by the system. See Zone Definition Status on page 28 for any exceptions.

7.1.7 **Follow (Full Arm) Zones**

Sections **[001]** to **[032]**: Zones 1 to 32, First Digits = **07**

Upon regular arming, the zone is Follow (see *Follow Zones* on page 25). Upon Stay or Sleep arming, the zone is bypassed by the system. See Zone Definition Status on page 28 for any exceptions.

7.1.8 **Instant Zones**

Sections **[001]** to **[032]**: Zones 1 to 32, First Digits = **08**

When an armed Instant Zone opens, the control panel immediately generates an alarm. Instant Zones are commonly used for windows, patio doors, skylights and other perimeter type zones. See Zone Definition Status on page 28 for any exceptions.

7.1.9 **Instant (Sleep / Full Arm) Zones**

Sections **[001]** to **[032]**: Zones 1 to 32, First Digits = **09**

When Regular or Sleep arming, the zone is Instant. When Stay arming, the zone is bypassed by the system. See Zone Definition Status on page 28 for any exceptions.

7.1.10 **Instant (Full Arm) Zones**

Sections **[001]** to **[032]**: Zones 1 to 32, First Digits = **10**

Upon Regular arming, the zone is Instant. Upon Stay or Sleep arming, the zone is bypassed by the system. See Zone Definition Status on page 28 for any exceptions.

7.1.11 Instant Fire Zones

Sections [001] to [032]: Zones 1 to 32, First Digits = 11

When a Instant Fire zone opens, whether it is armed or disarmed, the control panel will send the corresponding Alarm Report Code and the alarm is always audible regardless of other settings. Fire alarms generate an intermittent (pulsed) bell/siren output signal as shown in Figure 9 on page 26.

Figure 9: Bell/Siren Output during a Fire Alarm

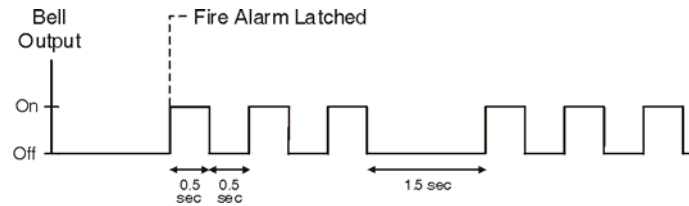

7.1.12 Delayed Fire Zones

Sections [001] to [032]: Zones 1 to 32, First Digits = 12

When a Delayed 24Hr. Fire zone opens, whether it is armed or disarmed, the control panel will react as shown in Figure 10. Delayed 24Hr. Fire zones are commonly used in residential homes where a smoke detector often generates false alarms (i.e., burning bread, etc.). Fire alarms generate an intermittent (pulsed) bell/siren output signal as shown in Figure 9 above.

Figure 10: Delayed 24Hr Fire Zone

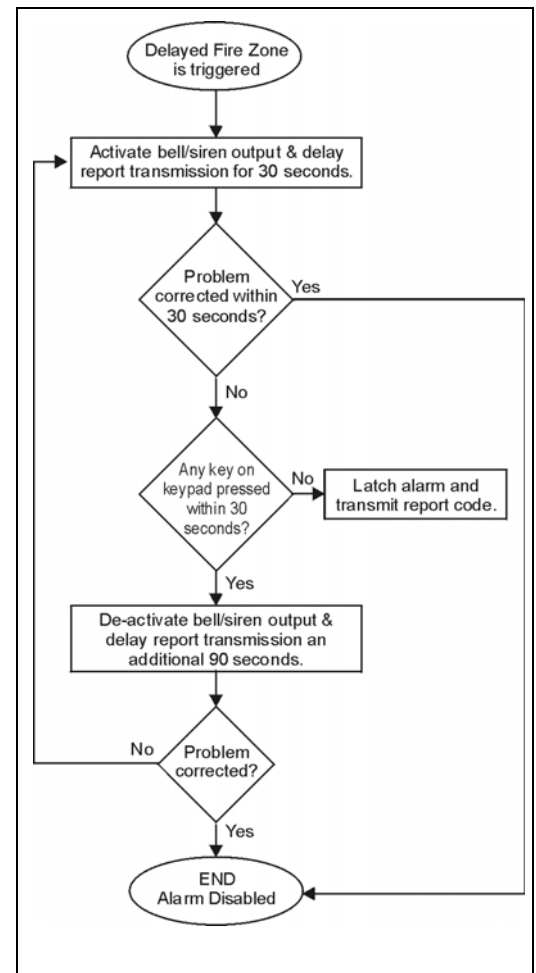

7.1.13 Instant Fire Silent Zones

Sections [001] to [032]: Zones 1 to 32, First Digits = 13

When a Instant Fire Silent zone opens, whether it is armed or disarmed, the control panel will generate the following: The control panel can send the corresponding Alarm Report Code and the alarm will be silent regardless of other settings.

7.1.14 Delayed Fire Silent Zones

Sections [001] to [032]: Zones 1 to 32, First Digits = 14

When a Delayed Fire zone opens, whether it is armed or disarmed, the control panel will react as shown in Figure 10. Delayed 24Hr. Fire zones are commonly used in residential homes where a smoke detector often generates false alarms (i.e., burning bread, etc.). The control panel can send the corresponding Alarm Report Code and the alarm will be silent regardless of other settings.

7.1.15 24 Hr. Buzzer Zones

Sections [001] to [032]: Zones 1 to 32, First Digits = 15

When a 24Hr Buzzer Zone opens, whether the zone is armed or disarmed, the control panel sets off the keypad's buzzers to indicate that the zone was breached. The control panel will report the alarm, but will not enable the bell/siren output. Enter any valid access code on the keypad to stop the buzzer. This zone definition is particularly useful when a user wishes to be notified when something such as a safe or locker within the home has been accessed (i.e. a child accessing a valuable collection).

7.1.16 24 Hr. Burglary Zones

Sections [001] to [032]: Zones 1 to 32, First Digits = 16

When a 24Hr Burglary Zone opens, whether the system is armed or disarmed, the control panel will immediately generate an alarm. This alarm is defined by the alarm type, configured in Zone Programming under zone options [4] and [5]. See Alarm Types on page 29.

7.1.17 24 Hr. Hold-up Zones

Sections **[001]** to **[032]**: Zones 1 to 32, First Digits = **17**

When a 24Hr. Hold-up zone opens, whether it is armed or disarmed, the control panel will immediately generate an alarm. This alarm is defined by the alarm type, configured in Zone Programming under zone options **[4]** and **[5]**. See Alarm Types on page 29. The SIA FSK and CID reporting formats include specific report codes to identify the alarm as a Hold-up alarm.

7.1.18 24 Hr. Gas Zones

Sections **[001]** to **[032]**: Zones 1 to 32, First Digits = **18**

When a 24Hr. Gas zone opens, whether it is armed or disarmed, the control panel will immediately generate an alarm. This alarm is defined by the alarm type, configured in Zone Programming under zone options **[4]** and **[5]**. See Alarm Types on page 29. The SIA FSK and CID reporting formats include specific report codes to identify the alarm as a Gas alarm.

7.1.19 24 Hr. Heat Zones

Sections **[001]** to **[032]**: Zones 1 to 32, First Digits = **19**

When a 24Hr. Heat zone opens, whether it is armed or disarmed, the control panel will immediately generate an alarm. This alarm is defined by the alarm type, configured in Zone Programming under zone options **[4]** and **[5]**. See Alarm Types on page 29. The SIA FSK and CID reporting formats include specific report codes to identify the alarm as a Heat alarm.

7.1.20 24 Hr. Water Zones

Sections **[001]** to **[032]**: Zones 1 to 32, First Digits = **20**

When a 24Hr. Water zone opens, whether it is armed or disarmed, the control panel will immediately generate an alarm. This alarm is defined by the alarm type, configured in Zone Programming under zone options **[4]** and **[5]**. See Alarm Types on page 29. The SIA FSK and CID reporting formats include specific report codes to identify the alarm as a Water alarm.

7.1.21 24 Hr. Freeze Zones

Sections **[001]** to **[032]**: Zones 1 to 32, First Digits = **21**

When a 24Hr. Freeze zone opens, whether it is armed or disarmed, the control panel will immediately generate an alarm. This alarm is defined by the alarm type, configured in Zone Programming under zone options **[4]** and **[5]**. See Alarm Types on page 29. The SIA FSK and CID reporting formats include specific report codes to identify the alarm as a Freeze alarm.

7.1.22 24Hr. Panic

Sections **[001]** to **[032]**: Zones 1 to 32, First Digits = **22**

When a 24Hr. Panic zone opens, whether it is armed or disarmed, the system will immediately generate an alarm. This alarm is defined by the panic options set in section **[702]**. The SIA FSK and CID reporting formats include specific report codes to identify the alarm as a Panic alarm. Section **[702]** option **[1]** (Panic 1) must be enabled for the 24Hr. Panic zone to function.

7.1.23 Instant No Pre-Alarm

Sections **[001]** to **[032]**: Zones 1 to 32, First Digits = **23**

This zone definition ignores the Flex-Instant delay, and acts like a traditional Instant zone.

7.1.24 Follow No Pre-Alarm

Sections **[001]** to **[032]**: Zones 1 to 32, First Digits = **24**

This zone definition ignores the Flex-Instant delay, and acts like a traditional Follow zone.

7.2 Zone Definition Status

There are eight zone definitions that are affected by the Flex-Instant delay (section [720]). The following table shows how the zone definition changes depending on the arm status and if the Flex-Instant delay is enabled. see *Zone Definition Status* on page 28.

Zone Definitions	Stay Arm	Sleep Arm	Fully Arm
01 = Entry Delay 1	Entry Delay 1	Entry Delay 1	Entry Delay 1
02 = Entry Delay 2	Entry Delay 2	Entry Delay 2	Entry Delay 2
03 = Entry Delay 1 (Full Arm)	Not Armed	Not Armed	Entry Delay 1
04 = Entry Delay 2 (Full Arm)	Not Armed	Not Armed	Entry Delay 2
05 = Follow	Follow*	Follow*	Follow
06 = Follow (Sleep/Full Arm)	Not Armed	Follow*	Follow
07 = Follow (Full Arm)	Not Armed	Not Armed	Follow
08 = Instant	Instant*	Instant*	Instant
09 = Instant (Sleep/Full Arm)	Not Armed	Instant*	Instant
10 = Instant (Full Arm)	Not Armed	Not Armed	Instant
23 = Instant No Pre-Alarm	Instant	Instant	Instant
24 = Follow No Pre-Alarm	Follow	Follow	Follow
* Flex-Instant = Zone will follow the delay at section [720], (default is 15 seconds / 0 = instant zone)			

7.3 Zone Partition Assignment

Sections [001] to [032]: Zones 1 to 32

The control panel provides the option of partitioning the security system into two completely independent systems. Sections [001] to [032] represent zones 1 through 32 respectively, where the third digit in each of these sections represents the zone's partition assignment. The zone is assigned to Partition 1 if third digit = 1, Partition 2 if third digit = 2, or both partitions is third digit = 3. For more details, see *Partitioning* on page 55.

7.4 Zone Options

Sections [001] to [032] represent zones 1 through 32 respectively. After entering the definition and partition assignment, select one or more of the following Zone Options by using the Multiple Feature Select Programming Method:

7.4.1 Auto Zone Shutdown

Sections [001] to [032] = Zones 1 to 32
 Option [1] OFF = Auto Zone Shutdown Disabled
 Option [1] ON = Auto Zone Shutdown Enabled for selected zone (default)

If, in a single armed period, the number of alarms generated by a zone with the Auto Zone Shutdown option enabled exceeds the number defined by the Auto Zone Shutdown Counter, the control panel will no longer generate an alarm for that zone. To program the Auto Zone Shutdown Counter, key in the desired limit (000=Disabled, 001 to 015, Default = 5) into section [712]. The Auto Zone Shutdown Counter resets every time a valid code is entered.

7.4.2 Bypassable Zones

Sections [001] to [032] = Zones 1 to 32
 Option [2] OFF = Bypass Zone Disabled
 Option [2] ON = Selected Zone is Bypass Enabled (default)

When a user utilizes the Bypass Programming feature (see *Bypass Programming* on page 22), only zones with the Bypass option enabled can be programmed as bypassed.



Do not program a fire zone with the Bypass option, as the control panel will never bypass fire zones.

7.4.3 RF Zone Supervision

Sections **[001]** to **[032]**: Zones 1 to 32
Option **[3]** OFF = RF Zone Supervision Disabled
Option **[3]** ON = RF Zone Supervision Enabled (default)

The panel waits for each of its assigned wireless transmitters to send a status signal within a specified time period (section **[706]**, option [1]) to confirm their presence and functionality. If a device has not sent a signal within that time period, the control panel can generate a trouble, an alarm, and/or transmit a report code to the monitoring station. See Trouble Display on page 60.

7.4.4 Alarm Types

Sections **[001]** to **[032]**: Zones 1 to 32

[4] OFF / **[5]** OFF: *Audible Steady* (default)

When the conditions for an alarm have been met, the control panel can transmit the appropriate Zone Alarm report code and provides a steady output for any bells or sirens connected to the control panel's bell output.

[4] OFF / **[5]** ON: *Audible Pulsed Alarm*

When the conditions for an alarm have been met, the control panel can transmit the appropriate Zone Alarm report code and provides a pulsed output (see Figure 9 on page 26) for any bells or sirens connected to the control panel's bell output.

[4] ON / **[5]** OFF: *Silent Alarm*

When the conditions for an alarm are met, the control panel can transmit the appropriate Zone Alarm report code and will not activate the control panel's bell output. The appropriate ARM or STATUS LED on the keypads will flash to indicate an alarm and the user will still have to disarm the system.

[4] ON / **[5]** ON: *Report Only*

When the conditions for an alarm have been met, the control panel can transmit the appropriate Zone Alarm report code. The system will not have to be disarmed.

7.4.5 Intellizone

Sections **[001]** to **[032]**: Zones 1 to 32
Option **[6]** OFF = Intellizone Disabled (default)
Option **[6]** ON = Intellizone Enabled for Selected Zone

This feature reduces the possibility of false alarms. When a zone with the Intellizone option opens, the panel does not immediately generate an alarm. First it triggers the Intellizone Delay Timer. To program the Intellizone Delay Timer, key in the desired 3-digit value (000 to 255 seconds, Default = 48 seconds) into section **[713]**. If any of the following conditions occur during this period, the panel will generate an alarm:

- During the Intellizone Delay, a second zone has caused an alarm.
- During the Intellizone Delay, the zone in alarm has restored (closed) and re-occurred (opened).
- The zone in alarm remains open for the entire Intellizone Delay.

7.4.6 Delay Alarm Transmission

Sections **[001]** to **[032]**: Zones 1 to 32
Option **[7]** OFF = Delay Alarm Transmission Disabled (default)
Option **[7]** ON = Delay Alarm Transmission Enabled for Selected Zone

When an alarm condition occurs on a zone with this option enabled, the control panel enables the bell/siren output, but does not report the alarm to the monitoring station until the end of the Delay Alarm Transmission. To program the Delay Alarm Transmission, key in the desired 3-digit delay value (000 = Disabled, 001 to 255 seconds) into section **[833]**. During this period, disarming the system disables the bell/siren output and cancels the report code transmission. This feature is commonly used with entry delay zones to reduce false alarms created by new users who may not disarm the system in time.

7.4.7 Force Zones

Sections **[001]** to **[032]**: Zones 1 to 32
Option **[8]** OFF = Force Zone Disabled
Option **[8]** ON = Selected Zone is Force Enabled (default)

Any open Force Zones at the time of arming will be considered deactivated by the control panel. If during this period a deactivated zone is closed, the control panel will revert that zone to active status. Consequently, the control panel will generate an alarm if the zone is breached.



Do not program a fire zone with the Force option, as the control panel will never bypass fire zones when Force arming.

7.5 EOL Zones

Section [706]: Zone Options

Option [2] OFF = Zones do not use EOL resistors (default)

Option [2] ON = Zones require EOL resistors

If all detection devices connected to the control panel have input terminals that require 1K Ω end of line resistors, enable option [2] in section [706]. For details on using EOL resistors, see *Single Zone Inputs* on page 12.

7.6 ATZ Zone Doubling

Section [705]: General Zone Options

Option [1] OFF = ATZ zone doubling disabled (default)

Option [1] ON = ATZ zone doubling enabled

Enabling ATZ Zone Doubling allows you to install two detection devices per input terminal.

7.7 Tamper Input on APR-ZX8 ID A (Panel + 1)

Section [706]: General Zone Options 2

Option [4] OFF = Zone A (default)

Option [4] ON = Tamper input

Enabling this option will make the first zone on the APR-ZX8 ID A (Panel +1) a tamper input. By default, it is a zone.

7.8 Tamper Input on APR-ZX8 ID B (Panel + 9)

Section [706]: General Zone Options 2

Option [5] OFF = Zone B (default)

Option [5] ON = Tamper input

Enabling this option will make the first zone on the APR-ZX8 ID B (Panel +9) a tamper input. By default, it is a zone.

7.9 Tamper Input on APR-ZX8 ID C (Panel + 17)

Section [706]: General Zone Options 2

Option [6] OFF = Zone C (default)

Option [6] ON = Tamper input

Enabling this option will make the first zone on the APR-ZX8 ID C (Panel +17) a tamper input. By default, it is a zone.

7.10 ATZ Wiring Options

Section [705]: General Zone Options

Option [2] OFF = ATZ Series (default)

Option [2] ON = ATZ Parallel doubling enabled

ATZ Zone Doubling can be configured in either a series or parallel connection.

7.11 Zone Input 1 Becomes a 2-wire Smoke Input

Section [706]: General Zone Options

Option [3] OFF = Zone input 1 is a standard zone input (default)

Option [3] ON = Zone input 1 becomes a 2-wire smoke input

With this option enabled, zone input 1 becomes a 2-wire smoke input (all panels except SP5500).

7.12 Zone Timers

Sections [041] to [044]: Zones 1 to 4

001 to 255 X 10ms, Default = 060

The Zone Timer defines how quickly the control panel will respond to an open zone. The control panel will not display an open zone on the keypad or generate an alarm until the programmed Zone Timer has elapsed. All other zone definitions and options do not come into effect until the Zone Timer has elapsed. This feature prevents any momentary glitches from causing an alarm or unnecessary reporting.

Part 8: Keyswitch Programming

8.1 Keyswitch Numbering

On-board hardware control panel zones only.

Keyswitch Numbering allows you to assign any hardwired input in the system to any of the 32 keyswitch zones in the control panel. **UL Note: Do not use keyswitches in UL Listed systems.**

8.2 Keyswitch Definitions

Keyswitch Definitions determine how a keyswitch is used.

8.2.1 Maintained Keyswitch

On-board hardware control panel zones only.

To arm a partition using the Maintained Keyswitch, turn the switch from the ON to the OFF position. Disarm it by setting the key on the ON position.

8.2.2 Momentary Keyswitch

On-board hardware control panel zones only.

To arm or disarm a partition using the Momentary Keyswitch, turn the keyswitch to the ON position for three seconds, then turn it to the OFF position.

8.3 Keyswitch Options

Each keyswitch zone can be programmed with one or more options.

8.3.1 Stay/Sleep Disarm Option (Keyswitch)

On-board hardware control panel zones only: Option 4

When enabled, the keyswitch can only disarm assigned Stay or Sleep armed partitions. When option [4] is disabled, the keyswitch can disarm partitions armed using any arming method.

8.3.2 Arm Only (Keyswitch)

On-board hardware control panel zones only: Option 5

When enabled, the keyswitch can only arm assigned partitions. The type of arming is determined by the other Keyswitch Options selected.

8.3.3 Stay Arming (Keyswitch)

On-board hardware control panel zones only: Option 6

Activating the keyswitch will Stay Arm the partition.

8.3.4 Sleep Arming (Keyswitch)

On-board hardware control panel zones only: Option 7

Activating the keyswitch will Sleep Arm the partition.



Only one of the arming options (Stay, Force, Instant and Regular) can be selected.

Part 9: Wireless Features

The control panel(s) allows for the addition of up to thirty-two fully supervised wireless transmitters, and up to thirty-two programmable remote controls.

9.1 Wireless Transmitter Programming

The programming of the wireless transmitters (detectors and door contacts) is accomplished in two steps:

1. Assign the wireless transmitter to the control panel.
2. Program the zones.

Wireless Transmitter Programming can be executed through the Installer Quick Menu in the programming guide.

Sections [061] to [092] represent expansion inputs 1 to 32 respectively.



The serial number is located on the inside of the transmitter or you can use the Serial Number Display (section [960]) to determine its serial number. The transmitters must be activated once having been assigned to the control panel. To activate a transmitter, insert the batteries and close the cover. To ensure proper synchronization between the control panel and the transmitter, open and close the zone corresponding to the transmitter.

How Do I Assign Wireless Transmitters to the Panel?

- 1) Press the [ENTER] key.
- 2) Enter your [INSTALLER CODE] (default: 0000 / 000000) or [MAINTENANCE CODE] (empty by default)
- 3) Enter the desired [SECTION NUMBER] (from sections [061] to [092]).
- 4) Enter the 6-digit [SERIAL NUMBER] of the wireless transmitter.

How Do I Delete Assigned Wireless Transmitters?

- 1) Press the [ENTER] key.
- 2) Enter your [INSTALLER CODE] (default: 0000 / 000000) or [MAINTENANCE CODE] (empty by default)
- 3) Enter the desired [SECTION NUMBER] (from sections [061] to [092]).
- 4) Press the [0] key six times to clear the serial number.

9.2 Viewing the Wireless Transmitter Signal Strength

Sections [101] to [132]

Once wireless transmitters have been installed and assigned to the control panel, the signal strength of each transmitter can be verified in sections [101] to [132]. Each section represents the signal strength viewer for a specific device. For example, section [101] is the viewer for zone 1 and section [132] is the viewer for the zone 32. Sometimes moving the transmitter or control panel by a small amount will greatly increase the signal reception.

How Do I View a Wireless Transmitter's Signal Strength?

- 1) Press the [ENTER] key.
- 2) Enter your [INSTALLER CODE] (default: 0000 / 000000) or [MAINTENANCE CODE] (empty by default)
- 3) Enter the desired [SECTION NUMBER] (from sections [101] to [132]).
- 4) Press the transmitter's anti-tamper switch or open the corresponding zone.
- 5) The keypad will illuminate numbers 1 to 10.

Signal Strength Indicator	8 to 10 / 3 beeps = Best signal	5 to 7 / 2 beeps = Average signal	1 to 4 / 1 beep = Weak signal (Relocate)
----------------------------------	---------------------------------	-----------------------------------	--

9.3 Supervision Options



The Supervision Options cannot be used with any remote controls assigned to the control panel.

9.3.1 Supervision Bypass Options

Section [705]: Arming/Disarming Options

Option [8] ON = Generate Supervision Loss if detected on a Bypassed Wireless Transmitter Zone (default)

Option [8] OFF = No Supervision Loss if detected on a Bypassed Wireless Transmitter Zone

When this feature is disabled, the Wireless Transmitter Supervision Options will follow the zone's bypass definition.

This means the control panel will not perform any action if a Supervision Loss occurs on a bypassed zone. When this feature is enabled, the Wireless Transmitter Options will ignore the bypass definition. This means the control panel will generate an incident as per Wireless Transmitter Supervision Options if a supervision loss occurs on a bypassed zone.

9.3.2 RF Module Supervision Timer Settings

Section [706]: Supervision Options

Option [1] OFF = Check-in supervision interval is every 24 hours (default)

Option [1] ON = Check-in supervision interval is every 80 minutes

Option [1] defines the time period that the control panel will expect a check-in status signal from its assigned wireless transmitters. For example, if the timer is set to 80 minutes (option [1] = ON), the control panel will expect a check-in status signal to be sent from its assigned wireless transmitters within 80 minutes. If the control panel does not receive a signal from one of its wireless transmitters within the period of time defined here, it can then generate a trouble, an alarm, and/or can transmit a report code to the monitoring station (see *Supervision Options* on page 32).

9.4 RF Jamming Supervision

Section [700]: Zone Options

Option [5] OFF = RF Jamming Supervision Disabled

Option [5] ON = RF Jamming Supervision Enabled (default)

With option [5] ON, a trouble will be generated when the panel's RF signal is jammed or encounters interference for a minimum of 10 seconds.

9.5 Wireless Serial Number Display

Section [960]: Find Wireless Serial Number Display

To see the wireless serial number display, enter section [960]. Press the anti-tamper switch of the desired module to be viewed. The first digit of the serial number will illuminate on the keypad. Press [ENTER] to see each consecutive digit. Press [CLEAR] to exit.

9.6 Remote Control Programming

The control panel accepts up to thirty-two fully programmable remote controls. Programming the remote controls is accomplished in two steps:

- 1) Assign the remote controls to the control panel.
- 2) Program the buttons on the remote controls.

9.6.1 Assigning a Remote Control to the Control Panel

Sections [651] to [682]: Remote Controls 1 to 32 respectively

Remote controls are assigned to the panel using the Automatic Learning method via the MAster Quick Menu Programming or by entering the serial number.

How Do I Assign a Remote Control to the Control Panel?

- 1) Press the [ENTER] key.
- 2) Enter your [INSTALLER CODE] (default: 0000 / 000000) or [MAINTENANCE CODE] (empty by default)
- 3) Enter the desired [SECTION NUMBER] (from sections [651] to [682]).
- 4) Enter the six-digit serial number of the remote.

9.6.2 Deleting Assigned Remote Controls

Sections [651] to [682]: Remote Controls 1 to 32 respectively

Remote controls can be deleted by deleting the corresponding user (see the Quick Menu in the user guide).

How Do I Delete a Remote Control?

- 1) Press the [ENTER] key.
- 2) Enter your [INSTALLER CODE] (default: 0000 / 000000) or [MAINTENANCE CODE] (empty by default)
- 3) Enter the desired [SECTION NUMBER] (from sections [651] to [682]).
- 4) Press the [0] button six times to delete the serial number.

9.6.3 Programming the Remote Control Buttons

Sections [611] to [642]: Remote Controls 1 to 32 respectively

Each remote control can be programmed to perform up to 4 different actions. Each digit in sections [611] to [642] represents a button or combination of buttons. Digits 1 through 4 can be programmed, while digits 5 through 8 are reserved for future use and must be defined as empty (reminder: [SLEEP] = empty).

How Do I Program the Remote Control's Buttons?

- 1) Press the [ENTER] key.
- 2) Enter your [INSTALLER CODE] (default: 0000 / 000000) or [MAINTENANCE CODE] (empty by default)
- 3) Enter the desired [SECTION NUMBER] (from sections [610] to [642]).
- 4) Enter the [HEXADECIMAL VALUE] (0 to F) of the desired button option from Table 4 on page 34 in the appropriate space. If you do not wish to program a button combination, press the [SLEEP] key to skip.



Warning: When section [610] is accessed, the panel will copy the saved value of that section to all remotes.

Table 4: Button Options

[0] = Button Disabled*	[8] = Generate a Panic 1 Alarm
[1] = Regular/Regular Force arming	[9] = Generate a Panic 2 Alarm
[2] = Stay/Stay Force arming	[0] or [0(10)] = Generate a Panic 3 Alarm
[3] = N/A	[OFF] = Activates any PGMs that have Event Group #08 as their Activation Event
[4] = Sleep/Sleep Force arming	[BYP] = Activates any PGMs that have Event Group #09 as their Activation Event
[5] = N/A	[MEM] = Activates any PGMs that have Event Group #10 as their Activation Event
[6] = N/A	[TBL] = Activates any PGMs that have Event Group #11 as their Activation Event
[7] = N/A	[⏻] = Paramedic alarm
* If you do not enter a value for a button, that button is disabled.	

9.7 Wireless Keypad Assignment

Sections [571] to [578]

Automatic Assignment: After panel power-up, the control panel will open a 10 minute window for Automatic Assignment. Press and hold the [⏻] and [BYP] key for three seconds on the respective keypad. The keypad is assigned to the control panel. Up to 8 wireless keypads can be assigned within the ten minute window.

Standard Assignment: Press [ENTER]. Enter your [INSTALLER CODE] or [MAINTENANCE CODE].

Go to section(s) [571] = Keypad 1, [572] = Keypad 2, [573] = Keypad 3, or [574] = Keypad 4, [575] = Keypad 5, [576] = Keypad 6, [577] = Keypad 7, or [578] = Keypad 8

Press and hold the [⏻] and [BYP] key for three seconds on the respective keypad. The keypad is assigned to the control panel. Alternatively, enter the serial number of the MG32LRF into one of the eight sections to assign it to the panel.

9.8 Viewing the Wireless Keypad Signal Strength

Sections [591] to [598]

Once wireless keypads have been installed and assigned to the control panel, the signal strength of each transmitter can be verified in sections [591] to [598]. Each section represents the signal strength viewer for a specific keypad. For example, section [591] is the viewer for keypad 1 and section [598] is the viewer for the keypad 8. Sometimes moving the keypad by a small amount will greatly increase the signal reception.

How Do I View a Wireless Keypad's Signal Strength?

- 1) Press the [ENTER] key.
- 2) Enter your [INSTALLER CODE] (default: 0000 / 000000) or [MAINTENANCE CODE] (empty by default)
- 3) Enter the desired [SECTION NUMBER] (from sections [591] to [598]).
- 4) Press the keypad's anti-tamper switch or open the corresponding keypad zone.
- 5) The keypad will illuminate numbers 1 to 10.

Signal Strength Indicator	8 to 10 / 3 beeps = Best signal	5 to 7 / 2 beeps = Average signal	1 to 4 / 1 beep = Weak signal (Relocate)
----------------------------------	---------------------------------	-----------------------------------	--

9.9 Wireless Keypad Options

Section [588]: Wireless Keypad Options

If enabled, the panel can wait for each of its assigned wireless transmitters to send a status signal within a specified time to confirm their presence and functionality.

- Option [1] OFF = Keypad 1 Supervision Disabled
- Option [1] ON = Keypad 1 Supervision Enabled (default)
- Option [2] OFF = Keypad 2 Supervision Disabled
- Option [2] ON = Keypad 2 Supervision Enabled (default)
- Option [3] OFF = Keypad 2 Supervision Disabled
- Option [3] ON = Keypad 2 Supervision Enabled (default)
- Option [4] OFF = Keypad 2 Supervision Disabled
- Option [4] ON = Keypad 2 Supervision Enabled (default)
- Option [5] OFF = Keypad 2 Supervision Disabled
- Option [5] ON = Keypad 2 Supervision Enabled (default)
- Option [6] OFF = Keypad 2 Supervision Disabled
- Option [6] ON = Keypad 2 Supervision Enabled (default)

- Option [7] OFF = Keypad 2 Supervision Disabled
- Option [7] ON = Keypad 2 Supervision Enabled (default)
- Option [8] OFF = Keypad 2 Supervision Disabled
- Option [8] ON = Keypad 2 Supervision Enabled (default)

9.10 Wireless Keypad Live Display Mode

Section [587]: Wireless Keypad Options

- Option [8] OFF = Live Display Mode Disabled
- Option [8] ON = Live Display Mode Enabled (default)

The MG32LRF has two display modes. By default, the keypad will show all events (e.g. zones in alarm, bypassed zones, etc.) live as they occur. Alternatively, with Live Display Mode off, the system will only display zones that cause an alarm or entry delay. If you want to see the status of all zones, press the [] key. Zones that are open but have not triggered an alarm will only be displayed after pressing the [] key. The display will appear for 30 seconds, showing the status of all zones at the time the [] key was pressed. The zone display will shut off after 30 seconds.

9.11 Wireless Repeater Programming

Sections [545] to [546] represent wireless repeater 1 and 2 respectively.

The wireless repeater module will improve the range of your system by retransmitting information from zones, PGMs, wireless keypads and the control panel. Note that all remote control signals are always repeated. You can have two MG-RPT1 per system. The wireless repeater also provides one PGM and one zone input with two-way wireless communication with the panel.

How Do I Assign Wireless Repeaters to the Panel?

- 1) Press the [ENTER] key.
- 2) Enter your [INSTALLER CODE] (default: 0000 / 000000) or [MAINTENANCE CODE] (empty by default)
- 3) Enter the desired [SECTION NUMBER] (from sections [545] to [546]).
- 4) Enter the 6-digit [SERIAL NUMBER] of the wireless repeater.

How Do I Delete Assigned Wireless Repeaters?

- 1) Press the [ENTER] key.
- 2) Enter your [INSTALLER CODE] (default: 0000 / 000000) or [MAINTENANCE CODE] (empty by default)
- 3) Enter the desired [SECTION NUMBER] (from sections [545] to [546])
- 4) Press the [0] key six times to clear the serial number.

9.12 Viewing the Repeater's Signal Strength

Sections [548] to [549]

Once the repeaters have been installed and assigned to the control panel, the signal strength of each repeater can be verified in sections [548] to [549]. Section [548] is the viewer for repeater 1 and section [549] is the viewer for the repeater 2. Sometimes moving the repeater or control panel by a small amount will greatly increase the signal reception.

How Do I View a Wireless Transmitter's Signal Strength?

- 1) Press the [ENTER] key.
- 2) Enter your [INSTALLER CODE] (default: 0000 / 000000) or [MAINTENANCE CODE] (empty by default)
- 3) Enter the desired [SECTION NUMBER] (from sections [548] to [549]).
- 4) Press the repeater's anti-tamper switch.
- 5) The keypad will illuminate numbers 1 to 10.

Signal Strength Indicator	8 to 10 / 3 beeps = Best signal	5 to 7 / 2 beeps = Average signal	1 to 4 / 1 beep = Weak signal (Relocate)
----------------------------------	---------------------------------	-----------------------------------	--

9.13 Wireless Repeater Options

Section [587]: Wireless Repeater Options

- Option [1] OFF = Repeater 1 Supervision Disabled
- Option [1] ON = Repeater 1 Supervision Enabled (default)
- Option [2] OFF = Repeater 2 Supervision Disabled
- Option [2] ON = Repeater 2 Supervision Enabled (default)

If enabled, the panel can wait for each of its assigned wireless transmitters to send a status signal within a specified time to confirm their presence and functionality.

9.14 Wireless Options

Section [551] (Repeater 1) and Section [561] (Repeater 2): Wireless Repeater Options

Enable or disable the repetition of wireless keypads in this section. Enabling these options for keypads means that the repeater will retransmit any signals relevant to them.

Option [1] OFF = Repeat Wireless Keypad 1 Signals (default)
Option [1] ON = Repeat Wireless Keypad 1 Signals

Option [2] OFF = Repeat Wireless Keypad 2 Signals (default)
Option [2] ON = Repeat Wireless Keypad 2 Signals

Option [3] OFF = Repeat Wireless Keypad 3 Signals (default)
Option [3] ON = Repeat Wireless Keypad 3 Signals

Option [4] OFF = Repeat Wireless Keypad 4 Signals (default)
Option [4] ON = Repeat Wireless Keypad 4 Signals

Option [5] OFF = Repeat Wireless Keypad 5 Signals (default)
Option [5] ON = Repeat Wireless Keypad 5 Signals

Option [6] OFF = Repeat Wireless Keypad 6 Signals (default)
Option [6] ON = Repeat Wireless Keypad 6 Signals

Option [7] OFF = Repeat Wireless Keypad 7 Signals (default)
Option [7] ON = Repeat Wireless Keypad 7 Signals

Option [8] OFF = Repeat Wireless Keypad 8 Signals (default)
Option [8] ON = Repeat Wireless Keypad 8 Signals

Section [552] (Repeater 1) and Section [562] (Repeater 2): Wireless Repeater Options

Enable or disable the repetition of zone signals in these sections. Enabling these options for zones means that the repeater will retransmit any signals relevant to them.

Option [1] OFF = Repeat Wireless Zone 1 Signals (default)
Option [1] ON = Repeat Wireless Zone 1 Signals

Option [2] OFF = Repeat Wireless Zone 2 Signals (default)
Option [2] ON = Repeat Wireless Zone 2 Signals

Option [3] OFF = Repeat Wireless Zone 3 Signals (default)
Option [3] ON = Repeat Wireless Zone 3 Signals

Option [4] OFF = Repeat Wireless Zone 4 Signals (default)
Option [4] ON = Repeat Wireless Zone 4 Signals

Option [5] OFF = Repeat Wireless Zone 5 Signals (default)
Option [5] ON = Repeat Wireless Zone 5 Signals

Option [6] OFF = Repeat Wireless Zone 6 Signals (default)
Option [6] ON = Repeat Wireless Zone 6 Signals

Option [7] OFF = Repeat Wireless Zone 7 Signals (default)
Option [7] ON = Repeat Wireless Zone 7 Signals

Option [8] OFF = Repeat Wireless Zone 8 Signals (default)
Option [8] ON = Repeat Wireless Zone 8 Signals

Section [553] (Repeater 1) and Section [563] (Repeater 2): Wireless Repeater Options

Enable or disable the repetition of zone signals in these sections. Enabling these options for zones means that the repeater will retransmit any signals relevant to them.

Option [1] OFF = Repeat Wireless Zone 9 Signals (default)
Option [1] ON = Repeat Wireless Zone 9 Signals

Option [2] OFF = Repeat Wireless Zone 10 Signals (default)
Option [2] ON = Repeat Wireless Zone 10 Signals

Option [3] OFF = Repeat Wireless Zone 11 Signals (default)
Option [3] ON = Repeat Wireless Zone 11 Signals

Option [4] OFF = Repeat Wireless Zone 12 Signals (default)
Option [4] ON = Repeat Wireless Zone 12 Signals

Option [5] OFF = Repeat Wireless Zone 13 Signals (default)
Option [5] ON = Repeat Wireless Zone 13 Signals

- Option [6] OFF = Repeat Wireless Zone 14 Signals (default)
- Option [6] ON = Repeat Wireless Zone 14 Signals
- Option [7] OFF = Repeat Wireless Zone 15 Signals (default)
- Option [7] ON = Repeat Wireless Zone 15 Signals
- Option [8] OFF = Repeat Wireless Zone 16 Signals (default)
- Option [8] ON = Repeat Wireless Zone 16 Signals

Section [554] (Repeater 1) and Section [564] (Repeater 2): Wireless Repeater Options

Enable or disable the repetition of zone signals in these sections. Enabling these options for zones means that the repeater will retransmit any signals relevant to them.

- Option [1] OFF = Repeat Wireless Zone 17 Signals (default)
- Option [1] ON = Repeat Wireless Zone 17 Signals
- Option [2] OFF = Repeat Wireless Zone 18 Signals (default)
- Option [2] ON = Repeat Wireless Zone 18 Signals
- Option [3] OFF = Repeat Wireless Zone 19 Signals (default)
- Option [3] ON = Repeat Wireless Zone 19 Signals
- Option [4] OFF = Repeat Wireless Zone 20 Signals (default)
- Option [4] ON = Repeat Wireless Zone 20 Signals
- Option [5] OFF = Repeat Wireless Zone 21 Signals (default)
- Option [5] ON = Repeat Wireless Zone 13 Signals
- Option [6] OFF = Repeat Wireless Zone 22 Signals (default)
- Option [6] ON = Repeat Wireless Zone 22 Signals
- Option [7] OFF = Repeat Wireless Zone 23 Signals (default)
- Option [7] ON = Repeat Wireless Zone 23 Signals
- Option [8] OFF = Repeat Wireless Zone 24 Signals (default)
- Option [8] ON = Repeat Wireless Zone 24 Signals

Section [555] (Repeater 1) and Section [565] (Repeater 2): Wireless Repeater Options

Enable or disable the repetition of zone signals in these sections. Enabling these options for zones means that the repeater will retransmit any signals relevant to them.

- Option [1] OFF = Repeat Wireless Zone 25 Signals (default)
- Option [1] ON = Repeat Wireless Zone 25 Signals
- Option [2] OFF = Repeat Wireless Zone 26 Signals (default)
- Option [2] ON = Repeat Wireless Zone 26 Signals
- Option [3] OFF = Repeat Wireless Zone 27 Signals (default)
- Option [3] ON = Repeat Wireless Zone 27 Signals
- Option [4] OFF = Repeat Wireless Zone 28 Signals (default)
- Option [4] ON = Repeat Wireless Zone 28 Signals
- Option [5] OFF = Repeat Wireless Zone 29 Signals (default)
- Option [5] ON = Repeat Wireless Zone 29 Signals
- Option [6] OFF = Repeat Wireless Zone 30 Signals (default)
- Option [6] ON = Repeat Wireless Zone 30 Signals
- Option [7] OFF = Repeat Wireless Zone 31 Signals (default)
- Option [7] ON = Repeat Wireless Zone 31 Signals
- Option [8] OFF = Repeat Wireless Zone 32 Signals (default)
- Option [8] ON = Repeat Wireless Zone 32 Signals

Section [556] (Repeater 1) and Section [566] (Repeater 2): Wireless Repeater Options

Enable or disable the repetition of MG-2WPGM signals in these sections. Enabling these options for MG-2WPGMs means that the repeater will retransmit any signals relevant to them.

- Option [1] OFF = Repeat Wireless 2-Way PGM 1 Signals (default)
- Option [1] ON = Repeat Wireless 2-Way PGM 1 Signals

- Option [2] OFF = Repeat Wireless 2-Way PGM 2 Signals (default)
- Option [2] ON = Repeat Wireless 2-Way PGM 2 Signals

- Option [3] OFF = Repeat Wireless 2-Way PGM 3 Signals (default)
- Option [3] ON = Repeat Wireless 2-Way PGM 3 Signals

- Option [4] OFF = Repeat Wireless 2-Way PGM 4 Signals (default)
- Option [4] ON = Repeat Wireless 2-Way PGM 4 Signals

- Option [5] OFF = Repeat Wireless 2-Way PGM 5 Signals (default)
- Option [5] ON = Repeat Wireless 2-Way PGM 5 Signals

- Option [6] OFF = Repeat Wireless 2-Way PGM 6 Signals (default)
- Option [6] ON = Repeat Wireless 2-Way PGM 6 Signals

- Option [7] OFF = Repeat Wireless 2-Way PGM 7 Signals (default)
- Option [7] ON = Repeat Wireless 2-Way PGM 7 Signals

- Option [8] OFF = Repeat Wireless 2-Way PGM 8 Signals (default)
- Option [8] ON = Repeat Wireless 2-Way PGM 8 Signals

Section [557] (Repeater 1) and Section [567] (Repeater 2): Wireless Repeater Options

Enable or disable the repetition of MG-2WPGM signals in these sections. Enabling these options for MG-2WPGMs means that the repeater will retransmit any signals relevant to them.

- Option [1] OFF = Repeat Wireless 2-Way PGM 9 Signals (default)
- Option [1] ON = Repeat Wireless 2-Way PGM 9 Signals

- Option [2] OFF = Repeat Wireless 2-Way PGM 10 Signals (default)
- Option [2] ON = Repeat Wireless 2-Way PGM 10 Signals

- Option [3] OFF = Repeat Wireless 2-Way PGM 11 Signals (default)
- Option [3] ON = Repeat Wireless 2-Way PGM 11 Signals

- Option [4] OFF = Repeat Wireless 2-Way PGM 12 Signals (default)
- Option [4] ON = Repeat Wireless 2-Way PGM 12 Signals

- Option [5] OFF = Repeat Wireless 2-Way PGM 13 Signals (default)
- Option [5] ON = Repeat Wireless 2-Way PGM 13 Signals

- Option [6] OFF = Repeat Wireless 2-Way PGM 14 Signals (default)
- Option [6] ON = Repeat Wireless 2-Way PGM 14 Signals

- Option [7] OFF = Repeat Wireless 2-Way PGM 15 Signals (default)
- Option [7] ON = Repeat Wireless 2-Way PGM 15 Signals

- Option [8] OFF = Repeat Wireless 2-Way PGM 16 Signals (default)
- Option [8] ON = Repeat Wireless 2-Way PGM 16 Signals

Part 10: Arming and Disarming Options

10.1 Switch to Stay Arming if no Entry Delay is opened

Section [741]: Partition 1, Section [742] = Partition 2
Option [5] OFF = Switch to Stay Arming Disabled (default)
Option [5] ON = Switch to Stay Arming Enabled

If a user Regular arms a partition, but does not exit through (open and close) an entry delay zone during the exit delay, the control panel can be programmed to switch from Regular arming to Stay arming.

10.2 When Delay Zone is bypassed Follow Zones become Entry Delay 2

Section [741]: Partition 1, Section [742] = Partition 2
Option [6] OFF = Follow zones become entry delay 2 when delay zone is bypassed disabled (default)
Option [6] ON = Follow zones become entry delay 2 when delay zone is bypassed enabled

If a user has an entry point defined as a delay, and a motion detector set as a follow zone, this option allows the user to bypass a delay zone so that the motion detector becomes an entry delay 2 zone. For example, if a user has a malfunctioning door contact, they can bypass the delay zone and have the motion detector become an entry delay 2 zone so that they have sufficient time to disarm the system. All follow zones become entry delay 2 if at least one delay zone is bypassed.

10.3 Regular Arming switches to Force Arming

(Not to be used with UL Installations)
Section [704]: Arming/Disarming Options
Option [1] OFF = Regular Arming Switches to Force Arming Disabled
Option [1] ON = Regular Arming Switches to Force Arming Enabled (default)

With this feature enabled, the control panel will always Force arm (if a force-enabled zone is open, see *Force Zones* on page 29) instead of Regular arm when a valid user access code with the Force Arming Option is entered.

10.4 Stay Arming switches to Stay Force Arming

(Not to be used with UL Installations)
Section [704]: Arming/Disarming Options
Option [2] OFF = Stay Arming Switches to Stay Force Arming Disabled
Option [2] ON = Stay Arming Switches to Stay Force Arming Enabled (default)

With this feature enabled, the control panel will always Stay Force arm (if a force-enabled zone is open, see *Force Zones* on page 29) instead of Stay arm when a valid user access code with the Force Arming Option is entered.

10.5 Sleep Arming switches to Sleep Force Arming

(Not to be used with UL Installations)
Section [704]: Arming/Disarming Options
Option [3] OFF = Sleep Arming Switches to Sleep Force Arming Disabled
Option [3] ON = Sleep Arming Switches to Sleep Force Arming Enabled (default)

With this feature enabled, the control panel will always Sleep Force arm (if a force-enabled zone is open, see *Force Zones* on page 29) instead of Sleep arm when a valid user access code with the Force Arming Option is entered.

10.6 Restrict Arming on Battery Failure

Section [703]: Arming/Disarming Options
Option [5] OFF = Permit arming on battery failure (default)
Option [5] ON = Restrict arming on battery failure

If this option is enabled, the control panel will not arm the system if the control panel detects that the backup battery is disconnected, that its fuse is blown, or that the battery voltage drops to less than 10.5V. The control panel will not arm the system until all battery trouble conditions are rectified.

10.7 Restrict Arming on Tamper Failure

Section [703]: Arming/Disarming Options
Option [6] OFF = Permit arming on tamper failure (default)
Option [6] ON = Restrict arming on tamper failure

If this option is enabled, the control panel will not arm the system if the control panel detects a tamper trouble on one or more zones. The control panel will not arm the system until all tamper trouble conditions are rectified.



This feature will not function if the tamper recognition options (see *Tamper Recognition* on page 43) are disabled or whenever the tampered zone is bypassed and the tamper bypass options have been enabled (see *Tamper Bypass Options* on page 44).

10.8 Restrict Arming on Wireless Supervision Trouble

Section [703]: Arming/Disarming Options

Option [7] OFF = Permit arming on wireless supervision failure (default)

Option [7] ON = Restrict arming on wireless supervision failure

If this option is enabled, the control panel will not arm the system if the control panel detects a wireless supervision trouble on one or more zones. The control panel will not arm the system until all wireless supervision trouble conditions are rectified.



This feature will not function if the tamper recognition options (see *Tamper Recognition on page 43*) are disabled or whenever the tampered zone is bypassed and the tamper bypass options have been enabled (see *Tamper Bypass Options on page 44*).

10.9 Arm/Disarm with VDMP3

Section [703]: Arming/Disarming Options

Option [8] OFF = Arm/Disarm with VDMP3 disabled

Option [8] ON = Arm/Disarm with VDMP3 enabled (default)

If this option is enabled, arming/disarming with the VDMP3 is functional. Disable the option if you do not want the ability to arm/disarm the system via telephone.

10.10 Timed Auto-Arming

Section [741] = Partition 1, [742] = Partition 2

Option [1] OFF = Timed Auto-Arming Disabled (default)

Option [1] ON = Timed Auto-Arming Enabled

Each partition can be programmed to arm every day at the time specified by the Auto-arm Timer. The auto-arming options (see *Auto-Arming Options on page 41*) determine the partition's arming method. Any open zones detected when a partition is auto-armed will be bypassed regardless of their definition (except 24Hr zones). The control panel will enter a 60-second exit delay period before arming the system. At this point, auto-arming can be cancelled by entering a valid access code. Once the partition has successfully armed, the control panel can transmit the Timed Auto-arming report code programmed in section [860].

Example: To automatically arm partition 2 everyday at 6:15PM, enable Timed Auto-arming for partition 2 by turning on option [1] in section [742]. Then key in 18:15 into section [762].

10.10.1 Auto-Arm Timer

Section [761] = Partition 1, [762] = Partition 2

Select the section corresponding to the desired partition and program the time (use the 24-hour clock i.e. 6:30PM = 18:30) that you wish the control panel to attempt to arm the selected partition and/or send the Late to Close report code.

10.11 No Movement Auto-Arming

Section [741] = Partition 1, [742] = Partition 2

Option [2] OFF = No Movement Auto-Arming Disabled (default)

Option [2] ON = No Movement Auto-Arming Enabled

If no movement occurs in a partition's protected area for the period specified by the No Movement Timer, the control panel can automatically arm that partition. The Auto-arming Option determines the partition's arming method. Any open zones detected when a partition is Auto-armed will be bypassed regardless of their definition (except 24Hr zones). Upon arming, the control panel will transmit the No Movement report code if programmed in section [860]. Regardless of whether the system was successfully armed or not, the control panel will always transmit the No Movement report code if programmed in section [860]. If No Movement Auto-arming is disabled, the control panel will still send the No Movement report code at the time specified by the No Movement Timer.

Example: To arm partition 1 whenever there is no movement for a period of 4 hours, enable No Movement Auto-arming for partition 1 by turning on the [2] Option in section [741]. Then in section [749] enter 016 (16x15min = 240min = 4 hours).

10.11.1 No Movement Timer

Section [749] = Partition 1, [750] = Partition 2

000 to 255 x 15 min, Default = Disabled

Select the section corresponding to the desired partition and program the interval of time without movement you wish the control panel to wait before arming and/or sending the No Movement report code. If No Movement Auto-arming is disabled, the control panel can still send the No Movement report code when no movement has been detected for the period specified by the No Movement Timer.

10.12 Auto-Arming Options

(Not to be used with UL installations)

Section [741] = Partition 1, [742] = Partition 2

[3]	[4]	
OFF	OFF	Regular
OFF	ON	Sleep
ON	OFF	Stay

When using Timed Auto-arming or No Movement Auto-arming, the control panel can Regular, Sleep or Stay arm the selected partition.

10.13 One-Touch Arming

(Not to be used with UL installations)

Section [703]: Options [1] to [3]

Option [1] ON = Press & hold the [ARM] key for One-touch Regular Arming.

Option [2] ON = Press & hold the [STAY] key for One-touch Stay Arming.

Option [3] ON = Press & hold the [SLEEP] key for One-touch Sleep Arming.

The One-touch arming features allow users to arm the system without having to enter any access codes. To arm the system, press and hold the appropriate key (see above) for approximately 3 seconds. If the system is partitioned, you must also press the key corresponding to the partition you wish to arm.

10.14 One-Touch Bypass Programming

(Not to be used with UL installations)

Section [703]: Options [4]

Option [4] ON = Press & hold the [BYP] key for One-touch Bypass Programming.

Bypass programming allows users to program the alarm system to ignore (deactivate) specified zones the next time the system is armed. Press and hold the [BYP] key for three seconds to access bypass programming mode.

10.15 Exit Delay

Section [745] = Partition 1, [746] = Partition 2

001 to 255 seconds, Default = 60 seconds, *Maximum 60 seconds for UL Listed systems*

After entering the required arming sequence (i.e. user access code, etc.), the exit delay parameter determines the amount of time a user has to leave the protected area before the control panel arms the partition. The exit delay applies to all zones in the selected partition. When enabled, the keypad will beep once every second during the exit delay and will beep rapidly during the final 10 seconds of the exit delay.

10.15.1 Beep On Exit Delay

Section [704]: Arming/Disarming Options

Option [6] OFF = Beep on Exit Delay Disabled

Option [6] ON = Beep on Exit Delay Enabled (default)

10.16 Bell Squawk On Arm/Disarm with Keypad

Section [704]: Arming/Disarming Options

Option [5] OFF = Bell Squawk on Arm/Disarm Disabled (default)

Option [5] ON = Bell Squawk on Arm/Disarm Enabled

When this feature is enabled, the bell or siren will squawk once upon arming and twice upon disarming via the keypad.

10.17 Bell Squawk On Arm/Disarm with Remote Control

Section [704]: Arming/Disarming Options

Option [4] OFF = Bell Squawk on Arm/Disarm with Remote Control Disabled (default)

Option [4] ON = Bell Squawk on Arm/Disarm with Remote Control Enabled

When this feature is enabled, the bell or siren will squawk once upon arming with a remote control and twice upon disarming with a remote control. Must be enabled for UL installations.

10.18 No Exit Delay When Arming with Remote Control

Section [704]: Arming/Disarming Options

Option [8] OFF = Provides Exit Delay When Arming with a Remote Control (default)

Option [8] ON = No Exit Delay When Arming with a Remote Control

When the option is enabled, the panel cancels the exit delay (arms instantly) when a partition is armed with a remote control. When disabled, the exit delay timer will start when a partition is armed with a remote control.

10.19 No Exit Delay Beeps and No Bell Squawk When Stay/Sleep Arming

Section [704]: Arming/Disarming Options

Option [7] OFF = No Exit Delay Beeps and No Bell Squawk When Stay/Sleep Arming Disabled

Option [7] ON = No Exit Delay Beeps and No Bell Squawk When Stay/Sleep Arming Enabled (default)

With this feature enabled, the control panel will prevent the bell or siren from squawking and the keypads from beeping during the exit delay, whenever a partition is Stay/Sleep armed.

10.20 Exit Delay Termination

Section [700]: Arming/Disarming Options

Option [6] OFF = Exit Delay Termination (Disabled)

Option [6] ON = Exit Delay Termination Enabled (default)

When option [6] is enabled (ON), the panel will reduce the Exit Delay to 10 seconds when an Entry Delay zone is opened and closed during the Exit Delay.

Example: 15 seconds into a 45 second Exit Delay, an Entry Delay zone opens and closes. The remaining 30 seconds is reduced to 10 seconds.

10.21 Fast Exit

When the system is already Stay or Sleep armed: This feature will allow you to exit and keep the system armed. Press and hold the [OFF] key for 3 seconds to start the exit delay. After the exit delay has elapsed, the system will switch to its previous arming mode.

Part 11: Alarm Options

11.1 Bell Cut-Off Timer

Section [747] = Partition 1, [748] = Partition 2

000 = Disabled, 001 to 255 minutes, Default = 4 minutes, **5 minutes minimum for ULC installations**

After an audible alarm, the bell or siren will stop upon disarming of the partition or when the Bell Cut-Off Timer has elapsed, whichever comes first.

11.2 Recycle Alarm

After the Bell Cut-Off Timer and the Recycle Delay have elapsed, the control panel will re-verify the zone status. If there are any open zones, the control panel will generate another alarm. In one armed period, the control panel will repeat this sequence the number of times defined by the Recycle Counter.

11.2.1 Recycle Alarm Delay

Section [714]

000 = disabled, 001 to 255 minutes, Default = Disabled

The Recycle Delay determines the amount of time after Bell Cut-Off that the control panel will wait before re-verifying zone status.

11.2.2 Recycle Alarm Counter

Section [715]

000 = disabled, 001 to 255, Default = Disabled

The Recycle Counter determines the number of times the control panel will re-verify the zone status after Bell Cut-Off in one armed period.

11.3 Tamper Recognition

11.3.1 Zones/RF Module and Keypad/Bus Module Tamper Recognition

Section [705]: Tamper Recognition Options

[3]	[4]	Zones/RF Module Tamper Recognition Options	Keypad / Bus Module Tamper Recognition Options*
OFF	OFF	Disabled	DISABLED
OFF	ON	TROUBLE ONLY	TROUBLE ONLY
ON	OFF	When disarmed: TROUBLE ONLY When armed: Follow zone's alarm type	TROUBLE ONLY
ON	ON	When disarmed: AUDIBLE ALARM When armed: Follow zone's alarm type	AUDIBLE ALARM

* Tamper recognition of keypad/bus module only if section [700] option [7] is enabled.

If a device has been tampered with (i.e. the anti-tamper switch has been set off), the control panel can generate a trouble, an alarm, and/or transmit a report code to the monitoring station. The system will react to an RF zone and a keypad/bus module differently.

11.4 RF Module Supervision

Section [705]: Supervision Options

[6]	[7]	RF Supervision Options	Keypad / Bus Module Supervision Options
OFF	OFF	Disabled	Disabled
OFF	ON	TROUBLE ONLY	TROUBLE ONLY
ON	OFF	When disarmed: TROUBLE ONLY When armed: Follow zone's alarm type	TROUBLE ONLY
ON	ON	When disarmed: AUDIBLE ALARM When armed: Follow zone's alarm type	AUDIBLE ALARM

The control panel waits for each of its assigned wireless transmitters to send a status signal within a specified time period to confirm their presence and functionality. If a device has not sent a signal within that time period, the control panel can generate a trouble, an alarm, and/or transmit a report code to the monitoring station. The system will react to an RF zone and a keypad/bus module differently.

11.5 Tamper Bypass Options

Section [705]: Zone Options

Option [5] OFF = Tamperers on bypassed zones will be ignored

Option [5] ON = Will generate a tamper if detected on a bypassed zone (default)

With option [5] off, the Tamper Recognition feature follows the zone bypass definition. This means the control panel will ignore any tampers detected on a bypassed zone. With option [5] on, Tamper Recognition ignores the bypass definition. This means the control panel will generate an incident as per Tamper Recognition settings if a tamper or wire fault occurs on a bypassed zone.

11.6 Tamper Supervision on the Bus Module

Section [700]: Supervision Options

Option [7] OFF = Tamper supervision disabled (default)

Option [7] ON = Tamper supervision enabled

When the control panel detects a tamper on a bus module, the control panel can generate an alarm or trouble, unless the Tamper Supervision is disabled.

11.7 Keypad Panic Options

Section [702]: General Options

Option [1] OFF = Panic 1 Disabled (default)

Option [1] ON = Panic 1 Enabled

Pressing the [1] and [3] keys simultaneously on the keypad for 3 seconds will generate a silent or audible alarm as defined by option [4].

Option [2] OFF = Panic 2 Disabled (default)

Option [2] ON = Panic 2 Enabled

Pressing the [4] and [6] keys simultaneously on the keypad for 3 seconds will generate a silent or audible alarm as defined by option [5].

Option [3] OFF = Panic 3 Disabled (default)

Option [3] ON = Panic 3 Enabled

Pressing the [7] and [9] keys simultaneously on the keypad for 3 seconds will generate a silent or audible alarm as defined by option [6].

Option [4] OFF = Panic 1 is Silent (default)

Option [4] ON = Panic 1 is Audible

Option [5] OFF = Panic 2 is Silent (default)

Option [5] ON = Panic 2 is Audible

Option [6] OFF = Panic 3 is Silent (default)

Option [6] ON = Panic 3 is Audible

Silent alarm:

The control panel emits a confirmation beep and transmits the appropriate Panic report code if programmed in section [863]. The control panel will not enable the keypad buzzers or the control panel's BELL output (no audible alarm).

Audible alarm:

Same as silent alarm, except the keypad buzzers and the BELL output will activate until a user cancels the alarm (disarms) with a valid user access code or when the Bell Cut-Off Timer elapses (see *Bell Cut-Off Timer* on page 43).



Whether the system is partitioned or not, the control panel will report all panic alarms to partition 1.

11.8 Panic Lockout Timer

Section [718]

When a panic alarm is activated, the control panel can ignore the disarm signal from a remote control for a specified period. This prevents an aggressor from disarming the system by remote control during a panic situation. In section [718] enter a 3-digit value (000 to 255, 000 = disabled) representing the number of seconds that the remote controls will be locked out of the system.

11.9 Flex-Instant Delay

Section [720]

The Flex-Instant Delay is used to prevent false alarms when the premises is Stay/Sleep armed. In section [720] enter a 3-digit value (000 to 255, 000 = disabled) representing the number of seconds that the panel will delay an alarm allowing you to disarm the system (default 15 seconds).

Part 12: Reporting and Dialer settings

The following section explains all the features and options that must be programmed in order for your security system to properly report system events to a monitoring station. When an event (e.g. zone in alarm) occurs in the system, the control panel verifies if a report code was programmed in the section corresponding to the event (except Ademco Contact ID "All Codes"). If a report code was programmed, the control panel will dial the monitoring station telephone number defined by the Event Call Direction feature. When the monitoring station answers, the control panel will transmit the System Account Code, followed by the programmed report code.

12.1 Zone Reporting Codes

Sections [141] to [172]

A report code can be programmed for each of the available 32 zones. When an alarm, alarm restore, tamper, or tamper restore occurs on a zone, the control panel can send the appropriate report code to the monitoring station.

12.2 User Reporting Codes

Sections [471] to [502]

A report code can be programmed for each of the available 32 users. When a user arms, disarms or cancels an alarm, the control panel can send the appropriate report code to the monitoring station.

12.3 Special Arming Report Codes

Sections [860] and [861]

When the system is armed using one of the special arming features listed below, the control panel can send the appropriate report code to the monitoring station identifying how the system was armed.

Section [860]

- **Auto-Arming:** A partition has armed itself at the programmed time.
- **Late to Close:** Reports every day at the time specified by the Auto-arm Timer.
- **No Movement:** No movement has been detected for the programmed amount of time in the partition.
- **Partial Arming:** A partition was Stay, Sleep, or Force armed or armed with Bypassed zones.

Section [861]

- **Quick Arming:** A partition was armed using a One-touch arming feature.
- **Arming via PC:** A partition was armed using the Winload software.
- N/A
- N/A

12.4 Special Disarming Report Codes

Section [862]

When using one of the special disarming features, the control panel can send the report code to the monitoring station, identifying how the system was disarmed.

- **Cancel Auto-Arm:** A partition is disarmed during the Timed Auto-arm's 60-second exit delay. Only reports if Disarming Reporting Options are set to always report disarming.
- **Disarming via PC:** System is disarmed using the WinLoad software. Only reports if Disarming Reporting Options are set to always report disarming.
- **Cancel alarm with user or WinLoad:** An alarm is cancelled using the WinLoad software.
- **Cancel Paramedic Alarm:** A paramedic alarm is cancelled.

12.5 Special Alarm Report Codes

Sections [863] and [864]

When the system generates an alarm due to one of the conditions listed below, the control panel can send the appropriate report code to the monitoring station identifying the type of alarm.

Section [863]

- **Emergency Panic:** Panic keys [1] and [3] have been pressed.
- **Auxiliary Panic:** Panic keys [4] and [6] have been pressed.
- **Fire Panic:** Panic keys [7] and [9] have been pressed.
- **Recent Closing:** Reports when an alarm is generated after arming the system within period defined by the Recent Close Delay.

Section [864]

- **Zone Shutdown:** A zone communicates more than the programmed number of transmissions in a single armed period.
- **Duress:** A Duress access code is keyed in.
- **Keypad Lockout:** If a consecutive number of invalid codes are entered into a keypad, the control panel can be set to deny access from all keypads for a specified period.
- **Paramedic Alarm:** A paramedic alarm is sent to the monitoring station.

12.6 System Trouble Report Codes

Section [865] to [869]

When the system generates one of the instances listed below, the control panel can send the appropriate report code to the monitoring station identifying the type of system trouble.

Section [865]

- N/A
- **AC Failure:** The control panel has detected a loss of AC power. Transmission of this report code can be delayed.
- **Battery Failure:** Backup battery is disconnected or battery voltage is low.
- **Auxiliary Supply:** Auxiliary power supply has overloaded.

Section [866]

- **Bell Output Overload:** Bell/siren output has overloaded.
- **Bell Output Disconnected:** Devices connected to the Bell Output have been disconnected.
- **Timer Loss:** The control panel has detected a loss in time or clock failure.
- **Fire Loop Trouble:** The control panel has detected a tamper trouble on a fire zone.

Section [867]

- **Fail To Communicate:** The control panel has failed all attempts to communicate with the monitoring station. The report code will be transmitted upon the next successful attempt.
- **RF Interference:** Will report if the RF signal is being jammed.
- **Module Lost:** The control panel has failed to communicate with one or more modules (including keypads).
- **Module Tamper:** The anti-tamper switch of a module (including keypads) has been triggered.

Section [868]

- **Module AC Fail:** The AC voltage of a module has dropped below recommended limits.
- **Module Low/No Battery:** The battery voltage of a module has dropped below recommended limits.
- **Wireless Zone Low Battery:** The battery voltage of a wireless transmitter has dropped below recommended limits.
- **Wireless Zone Supervision Lost:** The control panel has lost communication with a wireless zone.

Section [869]

- **Wireless PGM Supervision Lost:** The control panel has lost communication with a wireless PGM.
- **Wireless PGM Tamper:** The anti-tamper switch of a wireless PGM has been triggered.
- N/A
- N/A

12.7 System Trouble Restore Report Codes

Sections [870] to [874]

When the system restores one of the troubles listed in *System Trouble Report Codes* above, the control panel can send the appropriate report code to the monitoring station identifying the type of system trouble restore. If Telephone Line Monitoring is enabled, the control panel can also transmit a TLM Restore report code.

12.8 System Special Report Codes

Sections [875] to [876]

When the system generates one of the instances listed below, the control panel can send the appropriate report code to the monitoring station identifying the type of system occurrence.

Section [875]

- **Cold Start:** The control panel was completely shutdown (no battery, no AC) and then was re-started.
- **Test Report:** A test report has been generated automatically.
- **WinLoad In:** The control panel has commenced communication with WinLoad.
- **WinLoad Out:** The control panel has ended communication with WinLoad.

Section [876]

- **Installer In:** Installer/Maintenance has entered the programming mode.
- **Installer Out:** Installer has exited the programming mode.
- **Closing Delinquency:** The control panel will send a Closing Delinquency report code if the system has not been armed within a programmed amount of days.
- N/A

12.9 Clear Reporting Codes

Section [966]: Clear Reporting Codes

Option [1] OFF = Clear zone reporting codes

Option [1] ON = Clear zone reporting codes (default)

Option [2] OFF = Clear user reporting codes

Option [2] ON = Clear user reporting codes (default)

Option [3] OFF = Clear arm/disarm/alarm reporting codes

Option **[3]** ON = Clear arm/disarm/alarm reporting codes (default)

Option **[4]** OFF = Clear trouble reporting codes

Option **[4]** ON = Clear trouble reporting codes (default)

Enable all options you want to clear. The respective sets of reporting codes will be cleared after exiting the section.

12.10 Reset Reporting Codes

Section **[967]**: Reset Reporting Codes

Option **[1]** OFF = Reset zone reporting codes

Option **[1]** ON = Reset zone reporting codes (default)

Option **[2]** OFF = Reset user reporting codes

Option **[2]** ON = Reset user reporting codes (default)

Option **[3]** OFF = Reset arm/disarm/alarm reporting codes

Option **[3]** ON = Reset arm/disarm/alarm reporting codes (default)

Option **[4]** OFF = Reset trouble reporting codes

Option **[4]** ON = Reset trouble reporting codes (default)

Enable all options you want to reset to default. The respective sets of reporting codes will be reset after exiting the section.

12.11 Monitoring Station Telephone Numbers

Section **[815]** = Phone#1, **[816]** = Phone#2, **[817]** = Backup Phone#, **[818]** = Pager #, **[819]** = Numeric Message Sent with Pager Reporting: Up to 32 digits

The control panel can dial up to 2 different monitoring station telephone numbers. You can enter any digit from 0 to 9 and any special keys or functions (see Table 5 on page 47) up to a maximum of 32 digits. After the maximum dialing attempts (see *Maximum Dialing Attempts* on page 49) to one monitoring station telephone number have failed, the control panel will then dial the backup telephone number. If the Alternate Dial Option (see *Alternate Dial Option* on page 49) is enabled, the control panel will dial the programmed backup telephone number after every failed attempt. If no backup telephone number is programmed, the control panel will never report to the backup telephone number. Also see *Delay Between Dialing Attempts* on page 49.

Table 5: Special Keys for Telephone Numbers

Press	Action or Value
[OFF]	*
[BYP]	#
[MEM]	switch from pulse to tone dialing or vice versa
[TBL]	4-second pause
[SLEEP]	deletes current digit
[␣]	inserts blank space

12.12 Personal Dialing Numbers

Personal Dialing numbers are personal numbers (e.g. cellular, office) that the panel can call in case of an alarm or panic. To program these five numbers see the Communicator Menu in either the Master or User Quick Menu. To set the call parameters, see options **[5]**, **[6]**, and **[7]** of section **[804]**.

The panel will call these personal numbers if programmed in the event of any panic or alarm (default) and sound a bell tone. To program the delay between the call attempts, see section **[832]**. The panel can also be programmed to delay before sounding the bell tone, which can be programmed in section **[836]**.

The default delay is 20 seconds. To determine the length of time the bell tone sounds on the phone line, see section **[837]**. The default value is 003, meaning the 10 second bell tone will repeat itself 3 times after the initial sequence (total= 40 seconds).

12.13 Reporting Formats

Section **[810]**: 1st digit = Format for Phone #1, 2nd digit = Format for Phone #2

The panel can use a number of different reporting formats and each monitoring station telephone number can be programmed with a different reporting format. The first digit entered into section **[810]** represents the reporting format used to communicate with Monitoring Station Telephone Number 1, the second digit represents the reporting format used to communicate with Monitoring Station Telephone Number 2. The Backup Telephone Number uses the same reporting format as the last monitoring station telephone number that was dialed.

Table 6: Reporting Formats

Value Entered	Reporting Format
0	Ademco Slow (1400Hz, 1900Hz, 10BPS)
1	Silent Knight Fast (1400Hz, 1900Hz, 10BPS)
2	SESCOA (2300Hz, 1800Hz, 20BPS)
3	Ademco Express (DTMF 4+2)
4	Ademco Contact ID
5	SIA



If Hexadecimals (0 to FF) are used to program the report codes, verify that the pager also supports Hexadecimals. If the pager does not support Hexadecimals, use only the digits 0 to 9.

UL Note: The installer is required to verify the complete compatibility of the DAC Receiver and formats at least once per year.

12.13.1 Standard Pulse Formats

The control panel can use the Ademco slow, Silent Knight and SESCOA standard pulse reporting formats which will transmit the 2-digit (00 to FF) report codes programmed into sections [860] to [876]. (see Table 6 on page 48).

12.13.2 Ademco Express

The Ademco Express is a high-speed reporting format, which will transmit the 2-digit (00 to FF) report codes programmed into sections [860] to [876].

12.13.3 Ademco Contact ID

Ademco Contact ID is a fast communicator format that uses tone reporting instead of pulse reporting. This communicator format also uses a pre-defined list of industry standard messages and report codes that will suit most of your basic installation needs. Please refer to the Contact ID Report Codes List in the Programming Guide for a complete list of these report codes and messages. If the reporting codes are set at 0xFF, the panel will send the appropriate report code from the Automatic Report Code List in the programming guide. Alternatively, report codes can be programmed using the Ademco Contact ID Report Codes in the programming guide.

12.13.4 Event Call Direction

Section [802]: Options [1] to [3]; Arming/Disarming

Option [1] ON =Call MSTN 1

Option [2] ON =Call MSTN 2

Option [3] ON =Call Pager telephone number

Section [802]: Options [5] to [7]; Alarm/Alarm Restore

Option [5] ON =Call MSTN 1

Option [6] ON =Call MSTN 2

Option [7] ON =Call Pager telephone number

Section [803]: Options [1] to [3]; Tamper/Tamper Restore

Option [1] ON =Call MSTN 1

Option [2] ON =Call MSTN 2

Option [3] ON =Call Pager telephone number

Section [803]: Options [5] to [7]; Trouble/Trouble Restore

Option [5] ON =Call MSTN 1

Option [6] ON =Call MSTN 2

Option [7] ON =Call Pager telephone number

Section [804]: Options [1] to [3]; Special Reporting

Option [1] ON =Call MSTN 1

Option [2] ON =Call MSTN 2

Option [3] ON =Call Pager telephone number

Section [804]: Options [5] to [7]; Special Reporting

Option [1] ON =Call voice on zone alarm (burglary/fire)

Option [2] ON =Call voice on panic alarms

Option [3] ON =Call voice on paramedic alarm

The events are divided into six groups (see above) where each event group can be programmed to dial up to three telephone numbers (MSTN 1 & 2 and the Pager telephone number).

When a reportable event occurs in the system, the panel will begin dialing the numbers sequentially starting from MSTN 1 (if enabled), skipping any disabled numbers and stopping once all selected telephone numbers have been called. After a certain amount of failed attempts (section [831]) at trying to call the monitoring station, the control panel will then dial the selected backup telephone number (if enabled; see Programming Guide).

If the Alternate Dial option is enabled, the control panel will dial the programmed backup telephone number (if enabled) after every failed attempt. If no backup telephone number is programmed, the control panel will never report to the backup telephone number.

Example: The system is armed and zone 1 has been breached causing an alarm. If options [5] and [7] are OFF and option [6] is ON in section [802], the control panel will attempt to communicate with MSTN 2.

12.13.5 Account Numbers

Section [811]: Partition 1, Section [812]: Partition 2

All report codes are preceded by a 4-digit or 3-digit Partition Account Number to ensure correct identification in a partitioned system. Partition account numbers can be any hexa-digit from 1 to F. To enter a 3-digit account number, simply press the [SLEEP] key followed by a 3-digit account number. Also, when using 3-digit account numbers, you must use 1-digit report codes.

12.14 Dialing Method

Section [800]: Dialer Options

Option [6] OFF = Pulse Dialing (see *Pulse Ratio* on page 49).

Option [6] ON = Tone/DTMF Dialing (default)

12.15 Pulse Ratio

Section [800]: Dialer Options

Option [7] OFF = European Pulse Ratio of 1:2

Option [7] ON = U.S.A. Pulse Ratio of 1:1.5 (default)

When using Pulse dialing, you can select one of two Pulse Ratios. Although most European countries use the 1:2 pulse ratio, the 1:1.5 ratio may provide better results in some cases. The same applies for North American countries. If the 1:1.5 pulse ratio is not providing the desired results, the 1:2 ratio may be used.

12.16 Maximum Dialing Attempts

Section [831]

000 to 255 attempts, Default = 8 attempts

The value programmed in section [081] determines how many times the control panel will re-dial the same monitoring station telephone number before proceeding to the next number.

12.17 Maximum Dialing Attempts - VDMP3

Section [841]

000 to 255 attempts, Default = 8 attempts

The value programmed in section [841] determines how many times the control panel will re-dial the same telephone number before proceeding to the next number. The maximum dialing attempts programmed in this section is independent from those programmed in section [831] of the panel dialer used for monitoring station reporting.

12.18 Delay Between Dialing Attempts

Section [832]

000 to 255 seconds, Default = 20 seconds

This delay determines the amount of time the control panel will wait between each dialing attempt. **This section applies to the Plug-in Voice Dialer when using a VDMP3.**

12.19 Switch to Pulse on 5th Attempt

Section [800]

Option [3] OFF = Switch to Pulse on 5th Attempt Disabled (default)

Option [3] ON = Switch to Pulse on 5th Attempt Enabled

With option [3] ON, the control panel will switch to pulse dialing on the 5th attempt of reaching the monitoring station.

12.20 Alternate Dial Option

Section [800]: Dialer Options

Option [4] OFF = Alternate Dial Disabled (default)

Option [4] ON = Alternate Dial Enabled

With option [4] OFF, the control panel will dial the backup programmed in section [817] after all attempts to one monitoring station number have failed. With option [4] ON, the control panel will dial the backup number after every failed attempt.

12.21 Force Dial Option

Section [800]: Dialer Options

Option [5] OFF = Force Dial Disabled

Option [5] ON = Force Dial Enabled (default)

With option [5] is enabled, the panel will dial a telephone number even if no dial tone is present after 4 seconds.

12.22 Recent Closing Delay

Section [838]

000 = Disabled, 001 to 255 seconds, Default = Disabled

If after having armed the system, an alarm is generated within the period defined by the Recent Close Delay, the control panel will attempt to transmit the Recent Close report code programmed in section [863].

12.23 Auto Test Report

Sections [840]

000 = Disabled, 001 to 255 days, Default = Disabled

Section [850]: Time (HH:MM)

The control panel will transmit the Test Report report code programmed into section [875] after the number of days programmed into section [840] has elapsed at the time programmed into section [850]. Use the 24-hour clock to program the time (i.e. 6:30PM = 18:30). The first Test Report will be transmitted within 24 hours after the feature is enabled at the time programmed in [850].

Example: Section [840] = 005 and section [850] = 13:00. The first Test Report will be sent at 1 PM that day and then the report will be sent every 5 days at 1 PM.

12.23.1 Auto Test Report Transmission Options

Sections [800]

[3]	[4]	Auto-Test Report Transmission Options
OFF	OFF	Transmit the test report code every time the days programmed in section [840] have elapsed at the time programmed in section [850] (default).
OFF	ON	When disarmed: Transmit test report code every time the time programmed in section [852] has elapsed. When armed: Transmit test report code every time the time programmed in section [851] has elapsed.
ON	OFF	The control panel will transmit the test report code every hour on the minute value programmed in section [850] (the last two digits). Note that the first two digits of section [850] will be ignored. <i>E.g. If 10:25 was programmed into section [850], the test report code would be transmitted at the 25th minute of every hour, i.e. 11:25, 12:25, etc.</i>
ON	ON	The test report code will be transmitted when any of the conditions of the second and third options listed above (options [3] = OFF and [4] = ON / options [3] = ON and [4] = OFF) are met.

12.23.2 Armed Report Delay

Section [851]

000 = disabled, 001 to 255 minutes, Default = 5 min.

The Armed Report Delay determines the amount of time after an Arming event that the control panel will wait before sending a report.

12.23.3 Disarmed Report Delay

Section [852]

000 = disabled, 001 to 255 minutes, Default = 60 min.

The Disarmed Report Delay determines the amount of time after an Disarming event that the control panel will wait before sending a report.

12.24 Closing Delinquency Delay

Section [719]

000 = Disabled, 001 to 255 days, Default = Disabled

At midnight every day, the control panel will verify when the partition was last disarmed. If the partition has not been armed within the time programmed in the Closing Delinquency Delay, the control panel will transmit a Closing Delinquency event to the monitoring station.

Example: The Closing Delinquency Timer for partition 1 in section [719] is programmed for 005 days. The control panel verifies when partition 1 was last disarmed at midnight every day. If partition 1 was not armed within the last 5 days, the panel will transmit a Closing Delinquency event to the monitoring station. **The Closing Delinquency Event and timer apply only to partition 1.**

12.25 Power Failure Report Delay

Section [839]

001 to 255 minutes, Default = 15 minutes

The control panel will transmit the AC Failure report code programmed in section [865] after the Power Failure Report Delay period has elapsed.

12.26 Report System Disarming

Section [801]: Arming /Disarming Options

Option [1] OFF = Always Report Disarming

Option [1] ON = Report Disarming Only After Alarm (default)

With option [1] OFF, the control panel will send the Disarming report codes (see *Special Disarming Report Codes* on page 45) to the monitoring station every time the system is disarmed. With option [1] ON, the control panel will send the Disarming report codes to the monitoring station when the system is disarmed following an alarm.

12.27 Zone Restore Report Options

Section [801]: Zone Options

Option [2] OFF = Report On Bell Cut-Off (default)

Option [2] ON = Report On Zone Closure

With option [2] OFF, the panel will send the Zone Alarm Restore report codes to the monitoring station when the zone has returned to normal and the Bell Cut-Off Timer has elapsed. With option [2] ON, the panel will send the Zone Alarm Restore report codes to the monitoring station as soon as the zone returns to normal or when the system is disarmed.

12.28 Telephone Line Monitoring (TLM)

When enabled, the system verifies the existence of a telephone line once every second. A line test failure occurs when the TLM detects less than 3 volts for the period defined by the TLM Fail Timer. If the line test fails, the control panel's STATUS LED flashes and generates one or more conditions as defined by the TLM settings below. These will be restored when the control panel detects the telephone line again. Please note that when the dialer detects an incoming call, the TLM test will stop for 1 minute.

Section [800]: Dialer Options

[1] OFF / [2] OFF: *TLM Disabled*

[1] OFF / [2] ON: *Trouble Only*

Upon line test failure, a TLM Trouble will appear in the keypad's trouble display (see *Trouble Display* on page 60).

[1] ON / [2] OFF: *Audible Alarm If System Armed*

Upon line test failure, a TLM Trouble will appear in the keypad's trouble display (see *Trouble Display* on page 60) and if the system is armed, the control panel will generate an audible alarm.

[1] ON / [2] ON: *Silent Alarm Becomes Audible*

Upon line test failure, a TLM Trouble will appear in the keypad's trouble display (see *Trouble Display* on page 60) and causes a silent zone or silent panic alarm to switch to audible.

12.28.1 TLM Fail Timer

Section [830]

016 to 255 x 2 seconds, Default = 32 seconds

If TLM does not detect the existence of a telephone line for the duration of this period, the control panel will generate the condition(s) defined by the TLM options.

12.29 Pager Reporting Delay

Section [834]: Communication Timers

000 to 255 seconds, Default = 20 seconds

When using the Pager Reporting Format, the control panel will wait for the Pager Delay period before transmitting the report codes. This is to allow time for the pager system to provide a dial tone or to bypass the "welcome" message before sending data.

12.30 Pager Reporting Message Repetition

Section [835]: Communication Timers

000 to 255 times, Max. 10, Default = 3

When using the Pager Reporting Format, the control panel will repeatedly send the report codes to the pager until the transmission has been acknowledged.

12.31 Personal Reporting Delay

Section [836]: Communication Timers
000 to 255 times, Max. 127, Default = 5

When using the Personal Reporting Format, the control panel will wait for the Personal Delay period before transmitting the report codes. This is to allow time for the system to provide a dial tone or to bypass the “welcome” message before sending data. **This section applies to the Plug-in Voice Dialer when using a VDMP3.**

12.32 Personal Reporting Message Repetition

Section [837]: Communication Timers
000 to 255 times, Max. 10, Default = 3

When using the Personal Reporting Format, the control panel will repeatedly send the report codes to the pager until the transmission has been acknowledged. **This section applies to the Plug-in Voice Dialer when using a VDMP3.**

12.33 Disable Reporting

Sections [800]
Option [1] OFF = Dialer Activated (default)
Option [1] ON = No Dialer

With this option disabled (default), the control panel will continue to report events. With the option enabled, reporting is disabled.

Part 13: Programmable Outputs

A PGM is a programmable output that toggles to its opposite state (i.e. a normally open PGM will close) when a specific event has occurred in the system. For example, a PGM can be used to activate bells or strobe lights, open/close garage doors and much more. When a PGM activates, the control panel triggers any device or relay connected to it. The control panel includes two/four onboard PGMs. It can support up to a total of 16 PGMs.



A Wireless PGM module can be assigned to any PGM. It will work in parallel with the Control Panel Output.

13.1 PGM Activation Event

Sections [220], [222], [224], [226], [228], [230], [232], [234], [236], [238], [240], [242], [244], [246], [248], and [250]

This feature allows you to program the control panel to activate a PGM when a specific event occurs in the system. The PGM will remain in its active state until the programmed PGM Deactivation Event occurs or when the PGM Delay period elapses. For the Event List see the programming guide. To program a PGM Activation Event:

- 1) Enter section that represents the desired PGM. PGM1 = [220], PGM2 = [222], etc.
- 2) Enter the **Event Group #**.
- 3) Enter the **Sub-Group #**.
- 4) Enter the **Partition #** (01 = Partition 1 02 = Partition 2 99 = Both Partitions)



The “AC Loss” PGM Event will only occur after the power failure report delay elapses (see Power Failure Report Delay on page 51).

13.2 PGM Deactivation Event

Sections [221], [223], [225], [227], [229], [231], [233], [235], [237], [239], [241], [243], [245], [247], [249], and [251]

After PGM activation, the PGM will return to its normal state (deactivate) when the programmed PGM Deactivation Event occurs. Instead of deactivating the PGM when a specific event occurs, the PGM can deactivate after a programmed period elapses (see *PGM Delay* on page 53). For the Event List see the Programming Guide. ***If using the PGM Delay, these sections can be used as a second activation event.***

- 1) Enter section that represents the desired PGM. PGM1 = [221], PGM2 = [223], etc.
- 2) Enter the **Event Group #**.
- 3) Enter the **Sub-Group #**.
- 4) Enter the **Partition #** (01 = Partition 1 02 = Partition 2 99 = Both Partitions)

13.3 PGM Delay

Section [281] = PGM 1 to [296] = PGM 16,
001 to 255 sec./min., 000 = Follows Deactivation Event, Default = 5 seconds

Instead of deactivating the PGM on the occurrence of a specific event, the PGM will deactivate after the period programmed here has elapsed.



If a PGM Delay is programmed, the deactivation event can be used as a second activation event.

13.4 PGM Options

Section [261] to [276]: PGM Options

Option [1] OFF = PGM Base Time in Seconds (default)
Option [1] ON = PGM Base Time in Minutes

This option sets the PGM delay in increments of minutes or seconds.

Option [2] OFF = PGM State Normally Open (N.O.) (default)
Option [2] ON = PGM State Normally Closed (N.C.)

Option [3] OFF = PGM Supervision Disabled
Option [3] ON = PGM Supervision Enabled (default)

If enabled, the panel can wait for each of its assigned wireless transmitters to send a status signal within a specified time to confirm their presence and functionality.

Option [4] OFF = PGM Activation Mode Steady (default)
Option [4] ON = PGM Activation Mode Pulse

This option sets the PGM to be either steady (ON), or pulsed (ON/OFF) when it is activated.

Option [5] OFF = PGM Pulse once every 30 seconds disabled (default)

Option [5] ON = PGM Pulse once every 30 seconds enabled

When armed, the PGM will pulse once every 30 seconds.

Option [6] OFF = PGM Pulse on any alarm disabled (default)

Option [6] ON = PGM Pulse on any alarm enabled

This option sets the PGMs to pulse on any alarm.

Option [7] OFF = PGM Pulse on any alarm Partition 1 (default)

Option [7] ON = PGM Pulse on any alarm Partition 2

Program PGMs to pulse during an alarm for either partition. With this feature enabled, and in combination with the Follow Arm/Stay Arm/Sleep Arm PGM type, the PGM will mimic the Arm LED.

13.5 PGM Programming

Sections [301] to [316]

The programming of the PGMs is accomplished in two steps:

1. Assign the PGMs to the panel.
2. Program the PGMs.

PGM Programming can be executed through the Installer Quick Menu in the programming guide.

How Do I Assign PGMs to the Panel?

- 1) Press the [ENTER] key.
- 2) Enter your [INSTALLER CODE] (default: 0000 / 000000) or [MAINTENANCE CODE] (empty by default)
- 3) Enter the desired [SECTION NUMBER] (from sections [301] to [316]).
- 4) Enter the 6-digit [SERIAL NUMBER] of the PGM.

How Do I Delete Assigned PGMs?

- 1) Press the [ENTER] key.
- 2) Enter your [INSTALLER CODE] (default: 0000 / 000000) or [MAINTENANCE CODE] (default 1111/111111)
- 3) Enter the desired [SECTION NUMBER] (from sections [301] to [316]).
- 4) Press the [0] key six times to clear the serial number.

13.6 Viewing the PGM Signal Strength

Sections [321] to [336]

Once PGMs have been installed and assigned to the panel, the signal strength of each PGM can be verified in sections [321] to [336]. Sometimes moving the PGM or control panel by a small amount will greatly increase the signal reception.

How Do I View a Wireless Transmitter's Signal Strength?

- 1) Press the [ENTER] key.
- 2) Enter your [INSTALLER CODE] (default: 0000 / 000000) or [MAINTENANCE CODE] (empty by default)
- 3) Enter the desired [SECTION NUMBER] (from sections [321] to [336]).
- 4) Press the transmitter's anti-tamper switch or open the corresponding zone.
- 5) The keypad will illuminate numbers 1 to 10.

Signal Strength Indicator	8 to 10 / 3 beeps = Best signal	5 to 7 / 2 beeps = Average signal	1 to 4 / 1 beep = Weak signal (Relocate)
----------------------------------	---------------------------------	-----------------------------------	--

Part 14: System Settings

14.1 Version Number Display

Enter section [980] to view the version number of the panel. The first digit will appear. Press [ENTER] to scroll through each consecutive digit (the keypad will beep twice after every digit in the version number). Once the version number has been fully displayed, an acknowledgement beep (3 beeps) will sound and the first digit will be displayed again.

14.2 Push Button Power Reset

Performing a hardware reset will set all control panel settings to factory default except for the Panel ID and PC Password. Also, the event buffer will **not** be erased. To perform a push button power reset:

Press and hold the RESET switch for five seconds. The STATUS LED will start flashing fast. Within 2 seconds of this flashing, press the reset switch again. The panel will reset to default and restart

14.3 Installer Lock

Section [395]

000 = Disabled, 147 = Lock Enabled, Default = Disabled

Program 147 into section [395] to lock all programming. Performing a hardware reset will not affect the current panel settings. To remove the Installer Lock, enter 000. Please note that three seconds after turning on the control panel the STATUS LED and the relay on the control panel will flash fast for 6 seconds to indicate that the installer lock is enabled. Once enabled, the panel cannot be reset.

14.4 Keypad Lockout Feature

Sections [864]

If a consecutive number of invalid codes are entered into a keypad, the control panel can be set to deny access from all keypads for a specified period and send the report code programmed in section [864]. Program the number of consecutive invalid codes from 001 to 255 (000 = disabled) into section [717]. Program the duration of the Keypad Lockout from 001 to 255 minutes into section [716].

14.5 Battery Charge Current

Section [700]: General Options

Option [2] OFF = Battery Charge Current: 350mA (default)

Option [2] ON = Battery Charge Current: 700mA (40VA transformer required)

14.6 Partitioning

Section [700]: General Options

Option [1] OFF = Partitioning Disabled (default)

Option [1] ON = Partitioning Enabled

The panel is equipped with a partitioning feature which can divide the alarm system into two distinct areas identified as Partition 1 and Partition 2. Partitioning can be used in installations where shared security systems are more practical, such as an office/warehouse building. When partitioned, each zone, each user code (see *Access Codes* on page 21) and some of the system's features can be assigned to Partition 1, Partition 2 or both. ***If the system is not partitioned, all user codes and features will be recognized as belonging to Partition 1.***

- Users can only arm partitions to which they have been assigned.
- Only zones assigned to Partition 1 will arm/disarm when Partition 1 is armed or disarmed.
- Only zones assigned to Partition 2 will arm/disarm when Partition 2 is armed or disarmed.
- Zones assigned to both partitions will arm when both partitions are armed and will disarm when at least one disarms.
- The following features can be programmed separately for each partition: Entry/Exit Delay Timer, Auto-arming Options, Bell Cut-Off Timer, Switch to Stay arming, PGM Events and Account Numbers.



If the system is not partitioned, all zones, user codes, and features will be recognized as belonging to partition 1. Zones that have been manually assigned to partition 2 will no longer function.

14.7 Confidential Mode

Section [701] Options [3], [4] and [5]

Option [3] OFF = Confidential Mode Disabled (default)

Option [3] ON = Confidential Mode Enabled

Option [4] OFF = Keypads activate when an access code is entered (default)

Option [4] ON = Keypads activate when a key is pressed

Option [5] OFF = Confidential Mode Timer is 2 minutes (default)

Option [5] ON = Confidential Mode Timer is 5 seconds

If Confidential Mode is enabled and no actions are performed on the keypads for the time defined by the Confidential Mode Timer, all the keypad's LEDs will be off until either a key is pressed or an access code is entered. When the system exits Confidential Mode, the keypads will display the system's status. Confidential Mode is activated by enabling option [3]. Option [4] regulates whether the keypads will be activated at the touch of a key or only when an access code is entered. Option [5] determines the amount of time without action before the system enters Confidential Mode (5 seconds or 2 minutes).

14.8 Installer Function Keys

To access the Installer Function keys, press:

[ENTER]+[INSTALLER CODE]+[MEM] = *Test Report*: Send the "Test Report" report code programmed in section [875] to the monitoring station.

[ENTER]+[INSTALLER CODE]+[STAY] = *Cancel Communication*: Cancels all communication with the WinLoad software or with the monitoring station until the next reportable event.

[ENTER]+[INSTALLER CODE]+[STAY] = *Answer WinLoad Software*: Will force the control panel to answer an incoming call from the monitoring station that is using the WinLoad software.

[ENTER]+[INSTALLER CODE]+[BYP] = *Call WinLoad Software*: Will dial the PC telephone number programmed in section [915] in order to initiate communication with a computer using the WinLoad software.

[ENTER]+[INSTALLER CODE]+[TBL] = *Installer Test Mode*: The installer test mode will allow you to perform walk tests where the siren will squawk to indicate opened zones. Press the [TBL] key again to exit.

14.9 Daylight Savings Time

Section [730]: General Zone Options 2

Option [1] OFF = Daylight Savings Time Disabled (default)

Option [1] ON = Daylight Savings Time Enabled

With section [730] option [1] ON, the panel adjusts the system's clock (time) for daylight savings changes. At 2:00AM on the second Sunday of a full weekend in March, the control panel will add one hour to the programmed time (clock). At 2:00 AM on the first Sunday of a full weekend in November, the control panel will subtract one hour from the programmed time (clock). By default, when section [730] is set at 18, the time is set for the US, Canada etc. For other countries see Daylight Savings Programming in the programming guide and set the country code in section [731].

Country Code List (Default = bold)	
00 = US, Canada, Mexico, St.Johns, Bahamas, Turks and Caicos	09 = Lord Howe Island- Tasmania
01 = Cuba	10 = New Zealand, Chatham
02 = Brazil	11 = Tonga
03 = Chile	12 = Iraq and Syria
04 = Falklands	13 = Israel
05 = Paraguay	14 = Lebanon, Kirgizstan
06 = European Union, UK, and Greenland	15 = Palestine
07 = Russia and most states of the former USSR	16 = Egypt
08 = Australia- South Australia, Victoria, Australian Capital Territory, New South Wales	17 = Namibia
	18 = USA, Canada (New Daylight Saving Time for 2007)
	19 = New Zealand (New Daylight Saving Time for 2007)

14.10 Customized Daylight Saving Programming

In addition to using the default Daylight Saving Time (DST) settings in section [731], you can also set a customized DST. Set section [732] for the DST starting period and [733] for the DST ending period. Both sections recognize 5 different entries of 2 digits each. All entries must be assigned in this respective order:

Months	01 to 12	01 = January	*If the day is set at 00, the DST will automatically change on the programmed country code listed above.
Date	01 to 31	01 = First day of the month	
Day	00 to 07	00 = Default*, 01 = Sunday	
Hours	00 to 23	00 = Midnight	
Minutes	00 to 59	00 = 60 minutes or 1 hour	

Section	Data	Description
[732]	__/__/__/__/__/__/	Daylight Savings Time Starting Period
[733]	__/__/__/__/__/__/	Daylight Savings Time Ending Period

14.11 Audible Trouble Warning Except AC Failure

Section **[700]**: General System Options

Option **[3]** OFF = Audible trouble warning except AC failure (default)

Option **[3]** ON = Audible trouble warning except AC failure

When this option is enabled the panel will generate an audible trouble warning on all troubles except AC failure.

14.12 Audible Trouble Warning on AC Failure

Section **[700]**: General System Options

Option **[4]** OFF = Audible trouble warning on AC failure (default)

Option **[4]** ON = Audible trouble warning on AC failure

When this option is enabled the panel will generate an audible trouble warning in the event of an AC failure.

14.13 Display Entry Delay on LCD keypad (MG32LCD)

Section **[701]**: General System Options

Option **[7]** OFF = Display entry delay on LCD keypad

Option **[7]** ON = Display entry delay on LCD keypad (default)

When this option is enabled the panel will display entry delays on the MG32LCD keypad modules.

14.14 Display Exit Delay on LCD keypad (MG32LCD)

Section **[701]**: General System Options

Option **[8]** OFF = Display exit delay on LCD keypad

Option **[8]** ON = Display exit delay on LCD keypad (default)

When this option is enabled the panel will display exit delays on the MG32LCD keypad modules.

Part 15: Settings for WinLoad Software



WinLoad has not been verified by UL.

15.1 Panel Answer Options

The following two options define how the control panel answers an incoming call from a computer using the WinLoad Software for Windows®.

15.1.1 Answering Machine Override Delay

Section [902]

000 = Disabled, 000 to 255 seconds, Default = 030

When using the WinLoad software to communicate with an installation site that uses an answering machine or service, the answering machine override must be programmed. Using the WinLoad software you will call the control panel, hang up, then call back. If the installation site is called back within the programmed delay period, the control panel will override the answering machine or service by picking-up the line after the first ring on the second call. You must wait at least 10 seconds before attempting the second call, otherwise, the control panel will think it is the same call. For details on how to use the WinLoad software, refer to the WinLoad Help Manual. **This section applies to the Plug-in Voice Dialer when using a VDMP3.**

***Example:** A security installation is using an answering machine set to answer after three rings. If section [902] has been programmed with 040 (40 seconds) and the second call is made within 40 seconds, the control panel will pick up the line on the first ring. If it takes more than 40 seconds, the control panel will not answer on the first ring and the answering machine will answer after three rings.*

15.1.2 Number of Rings

Section [901]

000 = disabled, 001 to 015 rings, Default = 8 rings

This value represents the number of rings the control panel will wait before picking-up the line. If the line is not answered after the number of programmed rings, the control panel will answer the call. **This section applies to the Plug-in Voice Dialer when using a VDMP3.**

15.2 Panel Identifier

Section [910]

0000 to FFFF

This 4-digit code identifies the control panel to the WinLoad software before initiating communication. The control panel will verify that the Panel Identifier in the WinLoad software is the same. If the codes do not match, the control panel will not establish communication. Therefore, be sure to program the same panel identifier into both the control panel and the WinLoad software.

15.3 PC Password

Section [911]

0000 to FFFF

This 4-digit password identifies the PC to the panel before establishing communication. Program the same PC Password into both the control panel and the WinLoad software. If the passwords do not match, the WinLoad software will not establish communication.

15.4 PC Telephone Number

Section [915]

Up to 32 digits

The control panel will dial this number when trying to initiate communication with a computer using the WinLoad software. You can enter any digit from 0 to 9 and any special keys or functions up to a maximum of 32 digits.

15.5 Call WinLoad Software

[ENTER]+ [INSTALLER CODE] + [BYP]

The control panel will dial the PC Telephone Number programmed in section [915] in order to communicate with the WinLoad software. The control panel and the WinLoad software will verify that the Panel Identifier and the PC Password match before establishing communication.

15.6 Answer WinLoad Software

[ENTER] + [INSTALLER CODE] + [SLEEP]

In order to perform on-site upload/download connect your computer directly to the control panel using an ADP-1 line adapter. In the WinLoad software set Dialing Method to Blind Dial. Program the panel telephone number in WinLoad software and follow the instructions on the ADP-1 adapter. When the computer has dialed, press [ENTER] followed by the Installer/Maintenance Code, then press the [SLEEP] key to manually answer the WinLoad software from the control panel.

15.7 Automatic Event Buffer Transmission

Section [900]: Dialer Options

Option [2] OFF = Auto Event Buffer Transmission Disabled (default)

Option [2] ON = Auto Event Buffer Transmission Enabled

When the event buffer reaches 90% capacity, the control panel will make two attempts to establish communication with a PC using the WinLoad software by calling the PC Telephone Number programmed in section [915]. The WinLoad software must be in Wait to Dial mode. When the system establishes communication, it will upload the contents of the event buffer to the WinLoad software. If communication is interrupted before completing transmission or if after two attempts communication is not established, the system will wait until the Event Buffer attains another 90% capacity before attempting to re-communicate with the monitoring station. When the Event Buffer is full, each subsequent new event will erase the oldest event in the buffer.

15.8 Call Back WinLoad

Section [900]: Dialer Options

Option [1] OFF = Call Back WinLoad Disabled (default)

Option [1] ON = Call Back WinLoad Enabled

For additional security, when a PC using the WinLoad software attempts to communicate with the control panel, the control panel can hang up and call the PC back in order to re-verify identification codes and re-establish communication. When the control panel hangs up, the WinLoad software automatically goes into Wait for Call mode, ready to answer when the control panel calls back. Please note that the PC Telephone Number must be programmed in section [915] in order to use the Call Back feature.

15.9 Connecting to WinLoad

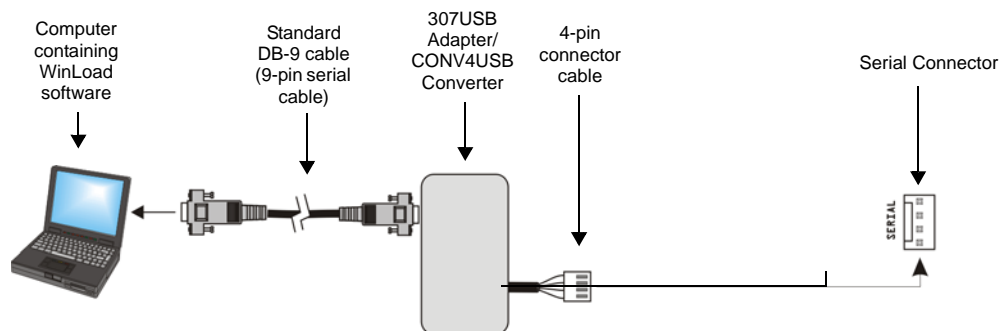

Part 16: User Operation

16.1 Alarm Display

If an alarm has occurred on a zone, the respective zone LED will flash, the **[MEM]** key will light up, and the zones will be stored in memory. These respective LEDs will continue to flash until disarming even if the zones are restored. To exit this mode and switch to live display mode before disarming, press the **[CLEAR]** key. Once the system is disarmed, the zones' LEDs will turn off, while the **[MEM]** key remains lit. Press the **[MEM]** key to illuminate the LEDs corresponding to the zones that were in alarm. The alarm memory will be erased when the next alarm occurs and after a valid code is entered or upon full-arming the system.

16.2 Trouble Display

Press the **[TBL]** key to view the Trouble Display. Please note that the keypad can be programmed to emit a beep every 5 seconds whenever a new trouble condition has occurred. Press the **[TBL]** key to stop the beeping.

To view the sub-menu, press the corresponding key in the main menu.

Main Menu Trouble	Sub-Menu Trouble Menu
[1] Wireless zone low battery	[1] to [32] Zones in low battery
[2] Power trouble	[1] Low/No battery on the control panel [2] AC failure on control panel [3] Auxiliary overload on control panel [4] Wireless keypad AC failure [5] Wireless keypad battery failure [6] Wireless repeater AC failure [7] Wireless repeater battery failure
[3] Bell trouble	[1] Bell disconnect on control panel [2] Bell overload on control panel
[4] Communication trouble	[1] Telephone Line Monitoring on control panel [2] Fail to communicate on Monitoring Telephone 1 on control panel [3] Fail to communicate on Monitoring Telephone 2 on control panel [4] Fail to communicate on pager telephone on control panel [5] Fail to communicate on voice telephone on control panel [6] Fail to communicate with PC on control panel
[5] Tamper and zone wiring failure	[1] to [32] Zones in tamper and zone wiring failure
[6] Module tamper trouble	[1] MG-2WPGM [2] Keypad bus [3] ZX8 Bus Module [4] RTX3 Bus Module [5] Wireless keypad
[7] Fire loop trouble	[1] to [32] Zones in fire loop trouble
[8] Timer loss	
[9] Wireless zone supervision loss	[1] to [32] Zones in supervision lost [STAY] RF interference trouble
[0 (10)] or [10] Module supervision loss	[1] MG-2WPGM [2] Keypad bus (Panel reset will not clear this trouble, clear it in section [955]) [3] ZX8 Bus Module [4] RTX3 Bus Module [5] Wireless keypad supervision failure [6] Wireless repeater supervision failure
[16] Keypad fault (MG32LED/MG32LRF only)	
[SLEEP] Keypad fault (MG10LEDV/H only)	

INDEX

Numerics	
24 Hr. Burglary Zones	26
24 Hr. Buzzer	26
24 Hr. Freeze Zones	27
24 Hr. Gas Zones	27
24 Hr. Heat Zones	27
24 Hr. Hold-up Zones	27
24 Hr. Water Zones	27
A	
AC Failure Report Code	46
AC Power	3
Access Codes	21
Length	21
Account	49
Ademco Contact ID	48
Ademco Express	48
Advanced Settings	23
Advanced Technology Zone (ATZ) Connections	13
alarm	44
Alarm Display	60
Alarm Options	43
Alarm Report Code Transmission, Delay	29
Alarm Types	29
Alternate Dial Option	49
Answer WinLoad Software	59
Answering Machine Override	58
Armed Report Delay	50
Arming and Disarming Options	39
ATZ Wiring Options	30
ATZ Zone Doubling	30
Audible	44
Audible Trouble Warning Except AC Failure	57
Audible Trouble Warning on AC Failure	57
Auto Event Buffer Transmission	59
Auto Force Arming	39
Auto Test Report	50
Auto Zone Shutdown	28
Counter	28
Report Code	45
Auto-Arming	
Options	41
Timer	40
Timing	40
Auxiliary Panic Report Code	45
Auxiliary Power	11
Auxiliary Supply Report Code	46
B	
Backup Battery	3
Battery Charge Current	55
Battery Failure Report Code	46
Battery, Backup	3
Beep On Exit Delay	41
Bell Cut-Off Timer	43
Bell Output	
Connection	11
Disconnected Report Code	46
Overload Report Code	46
Bell Squawk On Arm/Disarm	
With Keypad	41
With Remote Control	41
Bypassable Zones	28
C	
Call Back Feature	59
Call WinLoad Software	58
Cancel Auto-Arm Report Code	45
Charge Current	55
Closing Delinquency	50
Cold Start Report Code	46
Configuring The LED Keypads	16
Connecting	
Bells or Sirens	11
Fire Zones	14
PGMs	11
Single Zone Inputs	12
Telephone Lines	11
Counter, Auto Zone Shutdown	28
D	
Data Display Mode	16
Daylight Savings Time	56
Delay	42, 51
Before Alarm Report Code Transmission	29
Between Dialing Attempts	49
Power Failure Report	51
Delayed Fire Silent Zones	26
Delayed Fire Zones	26
Dial	50
Dialer settings	45
Dialing Attempts	49
Dialing Method	49
Disable Test Reporting	52
Disarmed Report Delay	50
Display	57
Display Entry Delay	57
Display Exit Delay	57
Duress	22
Duress Report Code	45
E	
Emergency Panic Report Code	45
Entry Delay 2 / Stay / Sleep Zones	25
Entry Delay on LCD keypad	57
Entry/Exit	23
Entry/Exit with a Keypad	23
Entry/Exit with a Remote Control	23
EOL Zones	30

Event Buffer Transmission	59	L	
Exit Delay	41	Late to Close Report Code	45
Exit Delay on LCD keypad	57	Length of Access Codes	21
F		Location and Mounting	3
Fail	51	Lock Master Code	22
Fail to Communicate Report Code	46	Lock-out	55
Feature Select Programming Method	15	Lockout	44
Features, Wireless	32	M	
Fire Circuits	14	Maintenance Code	21
Fire Loop Trouble Report Code	46	Maximum Dialing Attempts	49
Fire Panic Report Code	45	Memory Card	16
Flex	44	Message	51, 52
Follow / Stay / Sleep Zones	25	Mode	23
Follow / Stay Zones	25	Module Fault Report Code	46
Follow No Pre-Alarm	27	Mounting	3
Follow Zones	25	Multiple Feature Select Programming Method	15
Force	50	N	
Force Arming	22	No Arming	
Force Zones	29	On Battery Fail	39
G		On Tamper Trouble	39, 40
Ground	3	No Audible Feedback Upon Stay Arming	42
H		No Exit Delay When Arming with Remote Control	41
Hardware Reset	55	No Movement Auto-Arming	40
I		No Movement Report Code	45
Input Numbers		Number of Rings	58
Keyswitch Numbering	31	Numbers	49
Installation	3	O	
Installer		One-Touch Arming	41
Code	21	Report Code	45
Lock	55	Options	
Quick Functions Keys	56	Alarm	43
Installer In Report Code	46	Arming and Disarming	39
Installer Out Report Code	46	Auto-Arming	41
Instant / Stay / Sleep Zones	25	User code	21
Instant / Stay Zones	25	Zone	28
Instant Fire Silent Zones	26	Override Answering Machine	58
Instant Fire Zones	26	P	
Instant No Pre-Alarm	27	Pager	51
Instant Zones	25	Panel Answer Options	58
Intellizone	29	Panel Identifier	58
K		Panic	44
Key. See Memory Card		Panic Options	44, 53
Keypad		Partial Arming Report Code	45
Lockout Report Code	45	Partition Account Numbers	47
Panic Options	44	Partition Assignment, Zone	28
Keyswitch		Partitioning	55
Arm Only	31	Paths	23
Definitions	31	PC Password	58
Keyswitch Numbering	31	PC Telephone Number	58
Maintained	31	Personal	52
Momentary	31	Personal Dialing Numbers	47
Options	31	PGM	53
Stay/Instant Disarm	31	PGM (Control Panel)	

Activation Event	53	Fail to Communicate	46
Deactivation Event	53	Fire Loop Trouble	46
PGM Delay	53	Module Fault	46
PGM Activation, User Code Option	22	Timer Loss	46
Power	3	Wireless Low Battery	46
Power Failure Report Delay	51	Reporting	51, 52
Programmable Output Connections	11	Reporting and Dialer settings	45
Programmable Outputs	53	Reporting Formats	47
Programming		Reset, Hardware	55
Methods	15	Restrict Arming	
Using a Keypad	15	On Battery Fail	39
Wireless Features	32	On Tamper Trouble	39, 40
Pulse	49	RF Jamming Supervision	33
Pulse Ratio	49	RF Supervision	29
		Rings	58
Q		S	
Quick Arming	41	Silent	44
		Single Digit Data Entry Method (Decimal and Hexadecimal) 15	
R		Single Zone Inputs	12
Re-arm	23	Software, Upload/Download	15
Recent Close Delay	50	Special Alarm Report Codes	45
Recent Closing Report Code	45	Special Arming Report Codes	45
Recycle Alarm	43	Special Disarming Report Codes	45
Regular Arming Switches to Force Arming	39	Special Reporting Codes	46
Remote Arming Report Code	45	Standard Pulse Formats	48
Remote Controls		StayD	23
Deleting	33	Switch	49
Programming	33	Switch to Stay Arming	39
Programming Remote Control Buttons	33	System	51
Remote Disarm Report Code	45	Master Code	21
Repetition	51, 52	Settings	55
Report	51	Trouble Report Codes	46
Report Code, Special		Trouble Restore Codes	45, 46
Cold Start	46		
Installer In	46	T	
Installer Out	46	Tamper Bypass Options	44
Test Report	46	Tamper Recognition	43
Report Code, Special Alarm		Telephone Line Connection	11
Auto Zone Shutdown	45	Telephone Line Monitoring (TLM)	51
Auxiliary Panic	45	Telephone Number, PC	58
Duress	45	Telephone Numbers	47
Emergency Panic	45	Termination	42
Fire Panic	45	Test Report	
Keypad Lockout	45	Automatic	50
Recent Closing	45	Report Code	46
Report Code, Special Arming		Timed Auto-Arming	40
Late to Close	45	Report Code	45
No Movement	45	Timer	44, 50, 51
One-Touch Arming	45	Timer Loss Report Code	46
Partial Arming	45	TLM	51
Remote Arming	45	Transformer Requirements	3
Timed Auto-Arming	45	Transmission Options	50
Report Code, Special Disarming		Trouble Display	60
Cancel Auto-Arm	45		
Remote Disarm	45	U	
Report Code, System Trouble		Upload/Download Software	15
AC Failure	46	User Code Options	
Auxiliary Supply	46		
Battery Failure	46		
Bell Output Disconnected	46		
Bell Output Overload	46		

Arm Only	22
Bypass Programming	22
Partition 1 Assignment	21
Partition 2 Assignment	22
PGM Activation	22
Stay Arming	22
User Operation	60

W

When Delay Zone is bypassed Follow Zones become Entry Delay 2 39

Window	23
Winload Software	15
Wireless Features	32
Wireless Keypad Assignment	34
Wireless Keypad Live Display Mode	35
Wireless Keypad Options	34, 35
Wireless Low Battery Report Code	46
Wireless Repeater Option	36
Wireless Repeater Programming	35
Wireless Serial Number Display	33
Wireless Transmitters	
Check-in Supervision Timer Settings	33
Programming	32, 54
Viewing Signal Strength	32, 34, 54

Z

Zone Definition Status	28
Zone Definitions	24
Zone Input 1 Becomes a 2-wire Smoke Input	30
Zone Options	
Delay Before Alarm Report Code Transmission	29
Force Zones	29
Zone Programming	24
Zone Restore Report Options	51
Zone Shutdown, Auto	28
Zone Timers	30

For technical support in Canada or the U.S., call 1-800-791-1919, Monday to Friday from 8:00 a.m. to 8:00 p.m. EST. For technical support outside Canada and the U.S., call 00-1-450-491-7444, Monday to Friday from 8:00 a.m. to 8:00 p.m. EST. Please feel free to visit our website at www.paradox.com.